

Downlights Specification

GLE-ME35G04

— **MAGICUBE Series**



【Basic Parameters】

- Material: AL6063-T5, spraying surface
- Coating: White(RAL9003)
- Lighting direction: downward
- Light efficiency: 68LM/W
- Beam angle: 30°/45° optional
- UGR : ≤13(X=4H,Y=8H)
- Dimming method: Non/1-10V/DALI optional
- Color tolerance: SDCM≤3(ANSI)
- CRI: 90
- CCT: 2700/3000/3500/4000K optional
- Input voltage: AC220-240V
- Application: Indoor
- Installation: Recessed
- Power installation: External
- IP grade: IP20
- Certification: CE, ROHS, Reach
- Warranty: 3 years

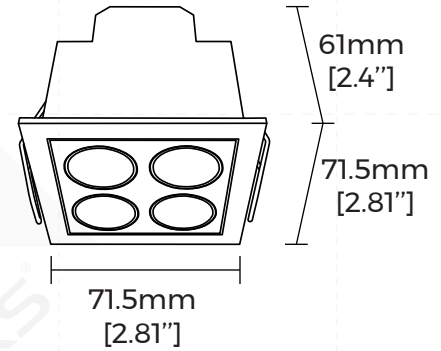

【Luminaire Parameters】

Model	Size (mm)	Hole size (mm)	Input Voltage (V)	Max. Current (A)	Type Power (W)	Beam angle (°)	CRI	CCT	Lumen (LM)
GLE-ME35G04	71.5*71.5*61 [2.81"*2.81"*2.4"]	63*63 [2.48"*2.48"]	AC220V-240V	0.7	10	30°	>90	2700K	630
								3000K	640
								3500K	660
								4000K	680
						45°		2700K	510
								3000K	520
								3500K	530
								4000K	540

Note:

1. The above parameters were tested based on Ra90, 4000K, light source;
2. luminous flux is allowed to have a ±10% error range;
3. The input voltage of the light source is 12V and the input current is 700mA
4. The above parameters are typical values.

[Optical Parameter]

Beam angle: 30°

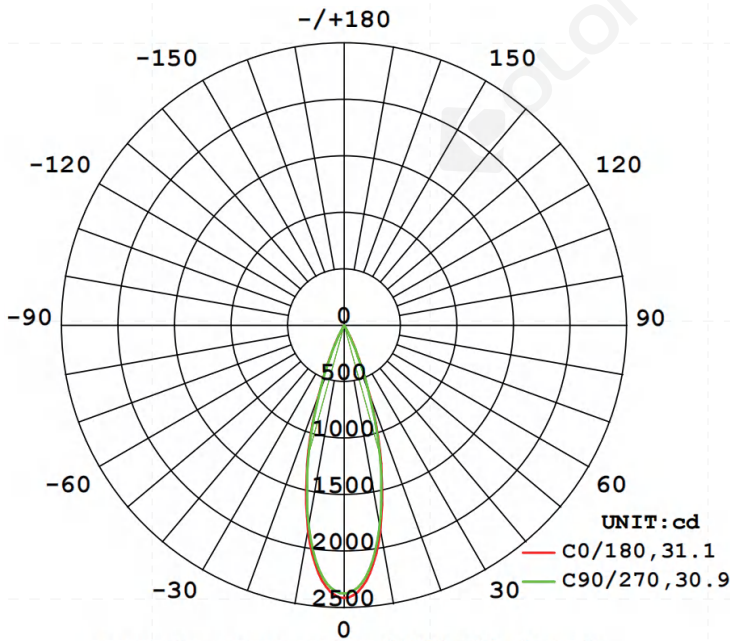

luminous intensity distribution diagram

Flux out: 416.1 lm

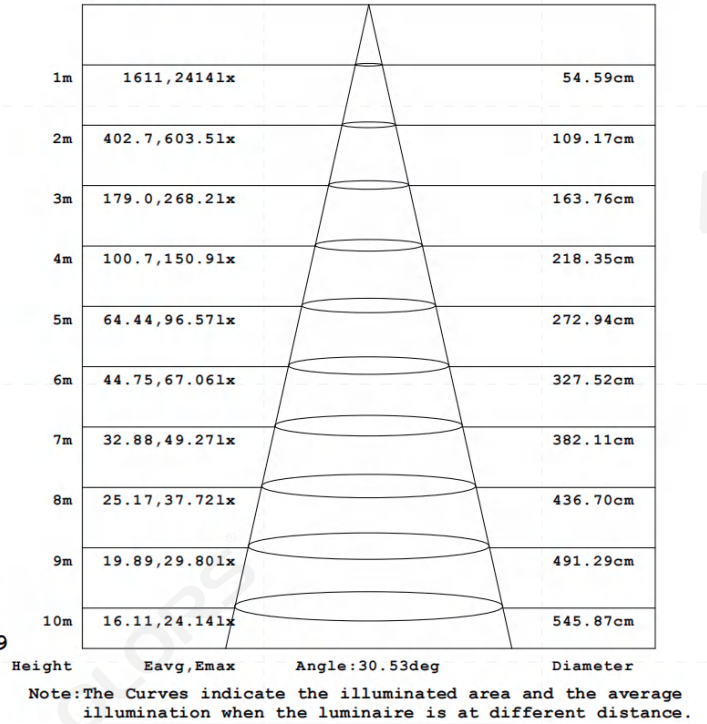

AAI Figure

Beam angle: 45°

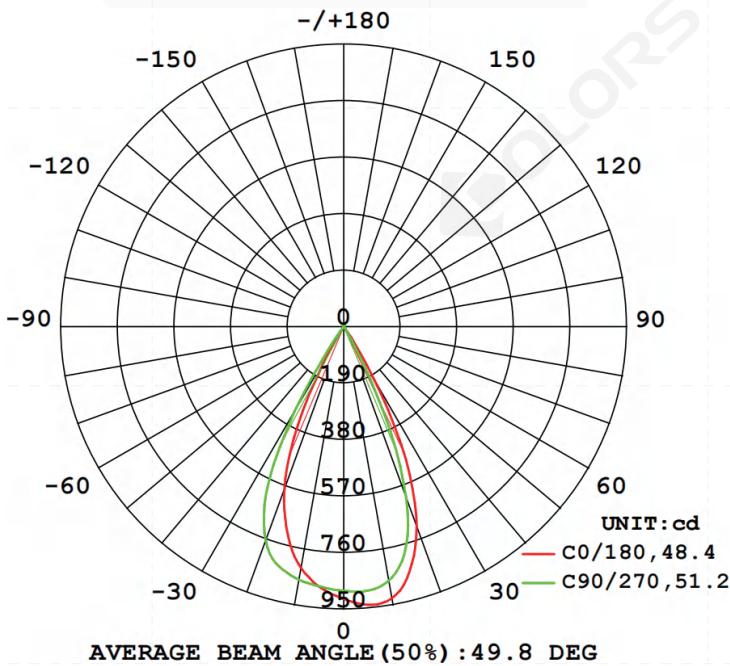

luminous intensity distribution diagram

Flux out: 423.7 lm

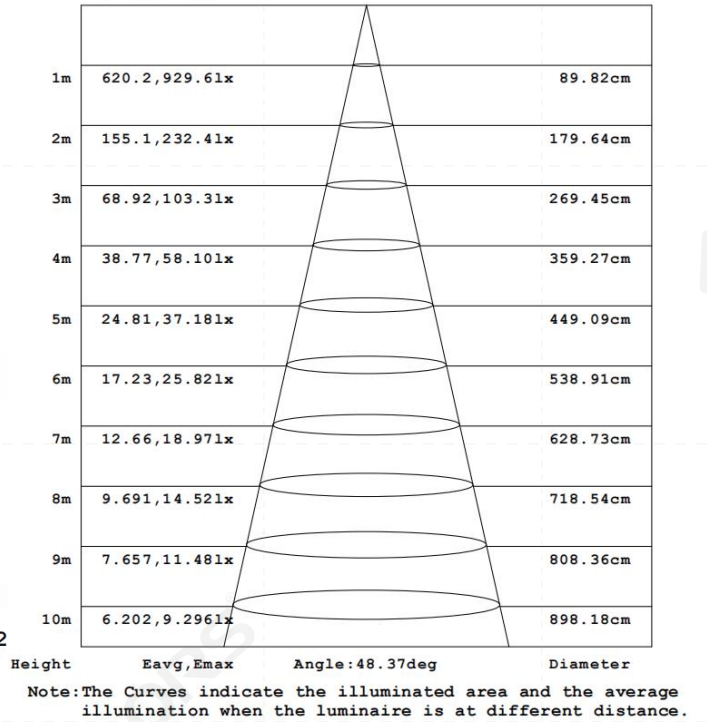

AAI Figure

[Product mechanical data]

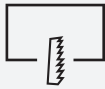
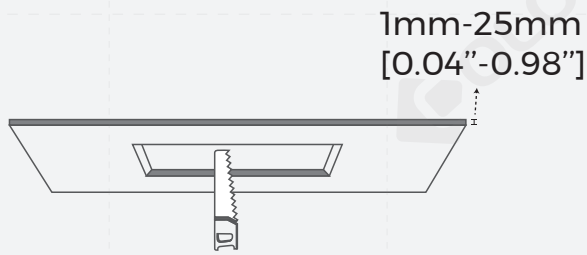

Hole size: 63×63mm
[2.48"×2.48"]

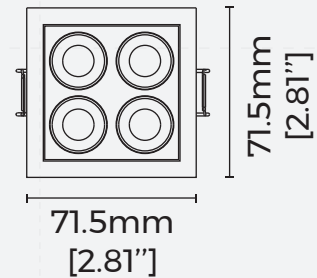
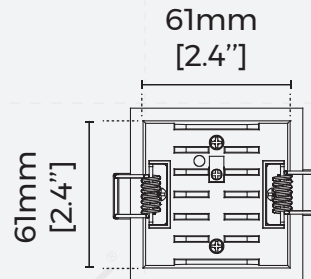
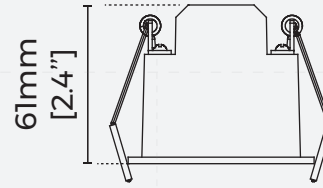

[Packing]

Model	Demension (mm)	Quantity /box	Quantity /carton	NW (kg)	NW /carton/(kg)	GW (kg)	Carton size (mm)
GLE-ME35G04	71.5*71.5*61 [2.81"*2.81"*2.4"]	1	9	0.275	2.475	4.475	416*350*95 [16.38"*13.78"*3.74"]

[Attentions]

- 1、 Non-professionals are prohibited from installing, disassembling and repairing the product.
- 2、 Avoid scratching, distortion and irregular bending of the product during installation; otherwise it may cause irreparable damage to the product.
- 3、 Please use professional cutting tools when cutting
- 4、 Do not use any acid or alkaline adhesive to fix products
- 5、 The product is only suitable for indoor dry places, can not be used in outdoor, seaside or wet environment.