

Downlight Specification

KE75L2

— KING series



【Basic Parameters】

- Material: ADC12, spraying surface
- Driver Installation: Remote
- IP grade: IP20
- CCT: 2700/3000/4000K optional
- CRI: 90
- SDCM(Light source): <3 Step (ANSI)
- Beam angle: 10°/15°/24°/38°/50° optional
- UGR(X=4H,Y=8H): ≤6(10°/15°/24°), ≤16(38°/50°)
- Lighting direction: downward
- Dimming method: Non / 1-10V / DALI optional
- Input voltage: AC220-240V
- Working temperature: -15°C-40°C
- Application: Indoor
- Installation: Recessed
- Certification: CE, ROHS, Reach
- Warranty: 5 years



【Border Color】



Black



White

【Reflector type】



Round



Pin hole



Oval

【Reflector Color】



Matte black



Matte white



Champagne Gold



Mirror



Black chrome

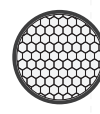

Honeycomb

【Optical Accessory】

【Product mechanical data】

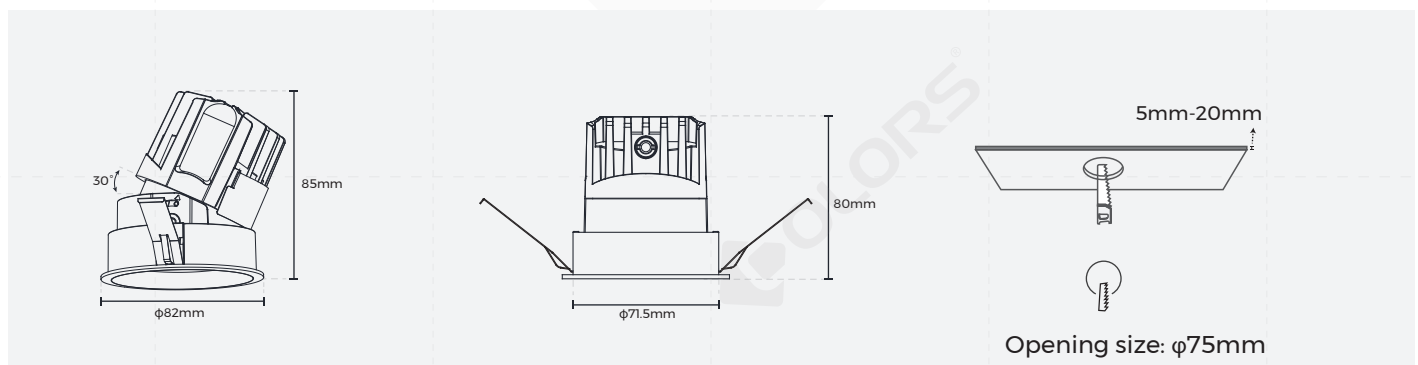

[Luminaire Parameters]

Model	Size (mm)	Opening Size (mm)	Input Voltage (V)	Input Current (mA)	Type Power (W)	CRI	Beam Angle	CCT	Lumen (LM)
KE75L2	φ82*80	φ75	DC36	200	8	>90	15°	2700K	430
								3000K	455
								4000K	490
							24°	2700K	645
								3000K	680
								4000K	730
					38°		2700K	720	
							3000K	760	
							4000K	820	
					50°		2700K	655	
							3000K	690	
							4000K	740	
				250	11		10°	2700K	425
								3000K	450
								4000K	485
					15°		10	2700K	540
								3000K	570
								4000K	615
				24°	2700K		800		
					3000K		840		
					4000K		905		
				38°	2700K		855		
					3000K		900		
					4000K		970		
50°	2700K	815							
	3000K	860							
	4000K	925							
300	12	15°	2700K	615					
			3000K	650					
			4000K	700					
	24°	2700K	890						
		3000K	935						
		4000K	1005						

KE75L2	φ82*80	φ75	DC36	300	12	>90	38°	2700K	1000
								3000K	1055
								4000K	1135
							50°	2700K	910
								3000K	960
								4000K	1030
				15°	2700K		685		
					3000K		720		
					4000K		775		
				24°	2700K		995		
					3000K		1050		
					4000K		1130		
				38°	2700K		1225		
					3000K		1290		
					4000K		1390		
				50°	2700K		1110		
					3000K		1170		
					4000K		1260		
				15°	2700K		775		
					3000K		815		
					4000K		875		
				24°	2700K		1130		
					3000K		1190		
					4000K		1280		
38°	2700K	1385							
	3000K	1460							
	4000K	1570							
50°	2700K	1260							
	3000K	1325							
	4000K	1425							
400	17	>90	38°	2700K	1000				
				3000K	1055				
				4000K	1135				
				50°	2700K	910			
					3000K	960			
					4000K	1030			
15°	2700K		685						
	3000K		720						
	4000K		775						
24°	2700K		995						
	3000K		1050						
	4000K		1130						
38°	2700K		1225						
	3000K		1290						
	4000K		1390						
50°	2700K		1110						
	3000K		1170						
	4000K		1260						
15°	2700K		775						
	3000K		815						
	4000K		875						
24°	2700K		1130						
	3000K		1190						
	4000K		1280						
38°	2700K	1385							
	3000K	1460							
	4000K	1570							
50°	2700K	1260							
	3000K	1325							
	4000K	1425							

Note:

1. The above parameters were tested based on Ra90, 3000K, light source;
2. The input voltage and input current belong to the light source.
3. The brand of the light source is CREE.
4. The brand of the driver is LIFUD or EAGLERISE.
5. The above parameters belong to the "Round" reflector type, and the light efficiency of the "Pin hole" reflector type and the "Oval" reflector type is 10% lower than that of "Round" reflector type
6. luminous flux is allowed to have a ±10% error range;
7. The above parameters are typical values.

[Optical Parameter]

· Type Power:8W

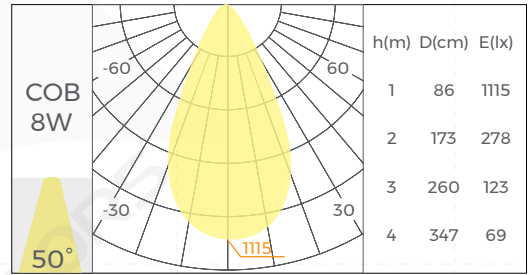
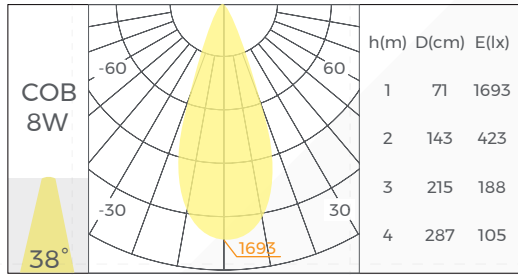
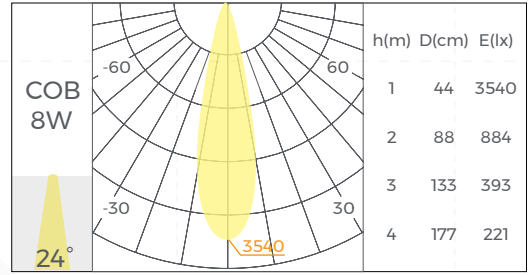
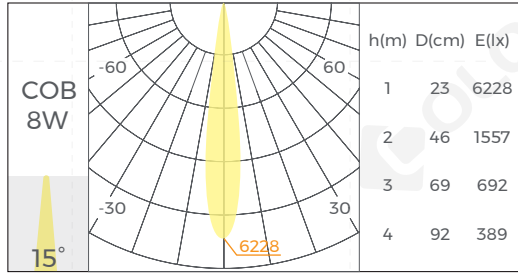

· Type Power:10W/11W

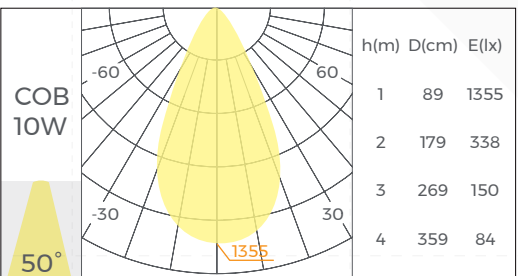
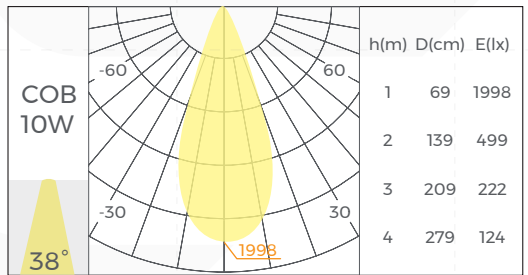
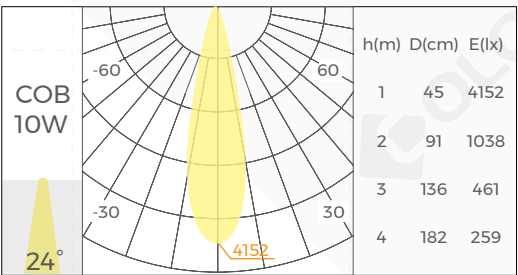
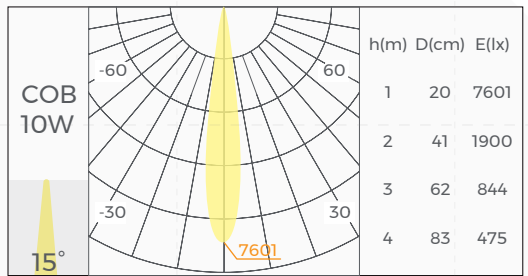
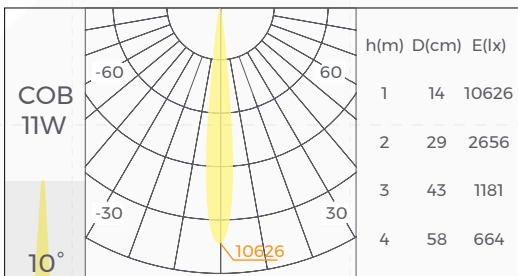

Type Power:12W

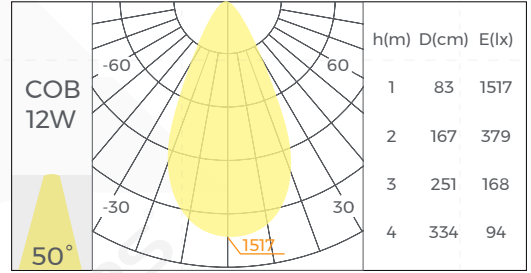
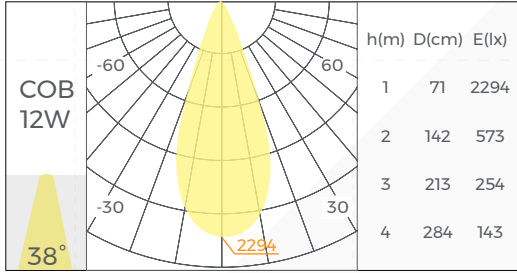
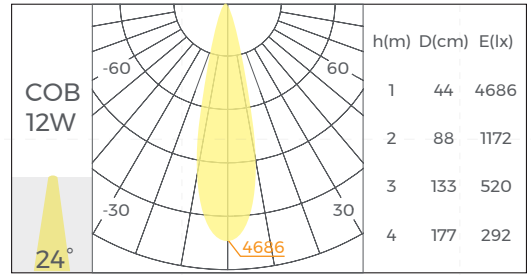
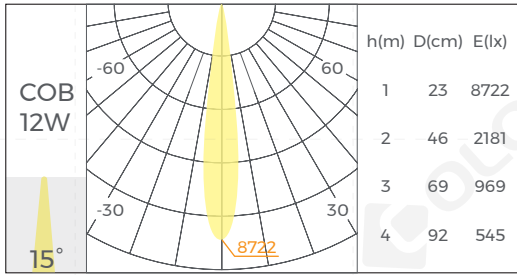

Type Power:15W

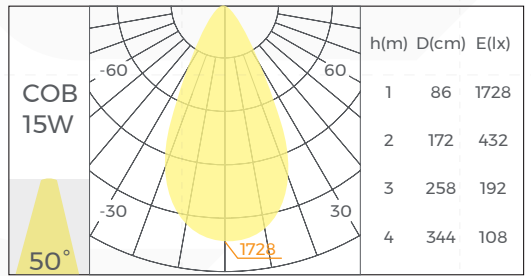
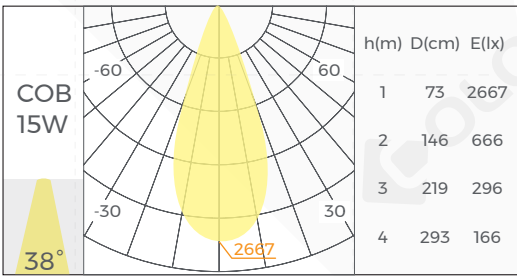
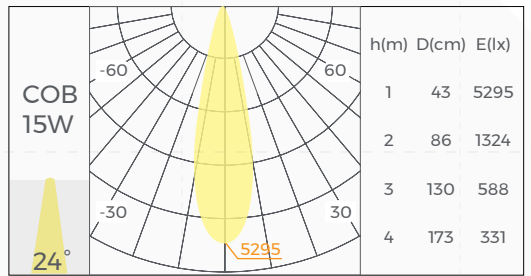
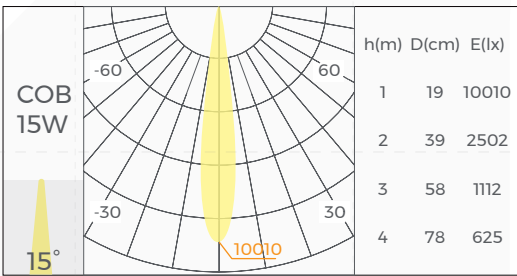

Type Power:17W

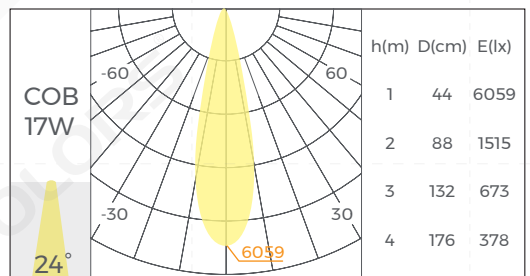
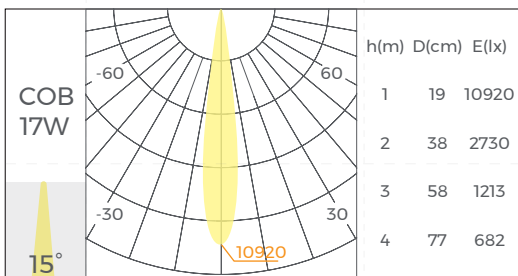

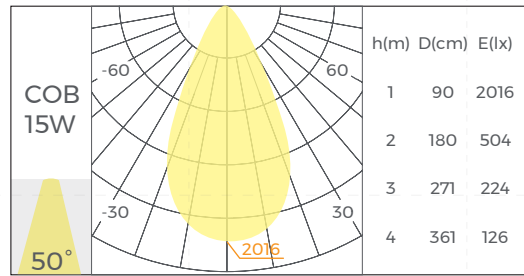
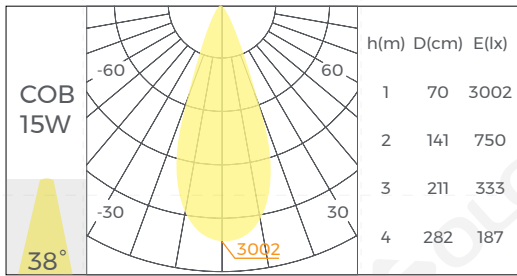

Note:

1. Central light intensity value = 1 meter maximum luminous intensity value;

1. N meter maximum luminous intensity value = Central light intensity value/N²;

For example: 2 meter maximum luminous intensity value = Central light intensity value/2²;

[Packing]

Model	Size (mm/box)	Quantity /box	Quantity /carton	NW (kg/box)	NW (kg/carton)	GW (kg)	Size (mm/carton)
DL-KE75L2-08903024-NWM	168*144*100	1	48	0.46	22.08	28	592*519*422

[Attentions]

1. Non-professionals are prohibited from installing, disassembling and repairing the product.
2. Avoid scratching, distortion and irregular bending of the product during installation; otherwise it may cause irreparable damage to the product.
3. Please use professional cutting tools when cutting
4. Do not use any acid or alkaline adhesive to fix products
5. The product is only suitable for indoor dry places, can not be used in outdoor, seaside or wet environment.