

Free-Dot System Specification

HM40S-30(N)

— HOLA series



【Basic Parameters】

- Installation: Ceiling
- Material: AL1070
- Coating: Black/White(Customizable) optional
- Dimming method: Non/DALI-2/CASAMBI
- Input voltage: DC48V
- SDCM: <3 Step (ANSI)
- UGR: <13
- CRI: 90
- CCT: 2700/3000/4000K optional
- Beam angle: 18°/24°/36°/50°
- Application: Indoor
- IP grade: IP20
- Warranty: 5 years
- Certification: CE、UKCA、ETL、ROHS、Reach

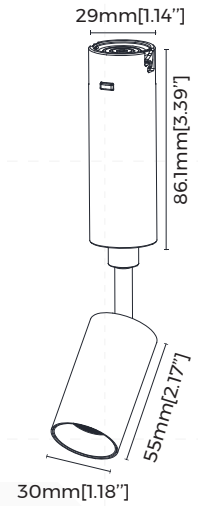

【Luminaire Parameters】

Version	Model	Length	Input Voltage (V)	Max. Current (A)	Type Power (W)	Max. Power (W)	CRI	Beam Angle	CCT	Lumen (LM)
Normal	HM40S-30(N)	/	DC48V	0.09	4	4.4	>90	18°/24°/36°/50°	2700K	270
									3000K	285
									4000K	310

Note:

1. The above parameters were tested based on 36°, Ra90, 4000K;
2. luminous flux is allowed to have a ±10% error range;
3. The above parameters are typical values.

[Optical Parameter]

· Beam angle: 18°

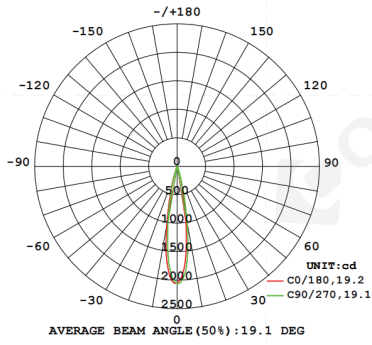

luminous intensity distribution diagram

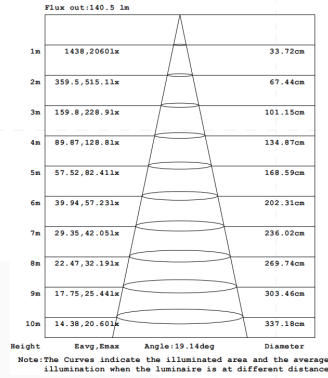

AAI Figure

· Beam angle: 24°

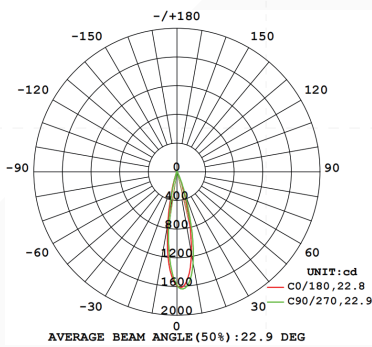

luminous intensity distribution diagram

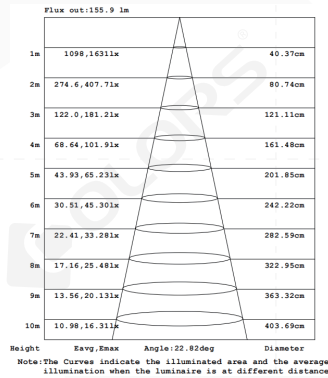

AAI Figure

· Beam angle: 36°

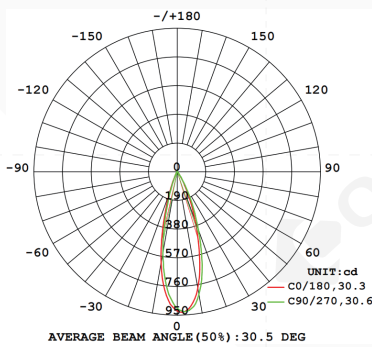

luminous intensity distribution diagram

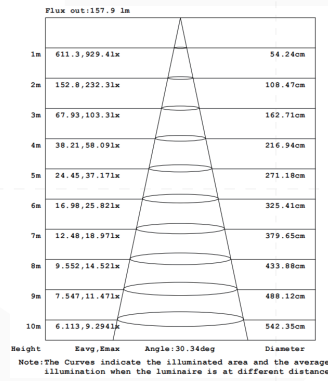

AAI Figure

· Beam angle: 50°

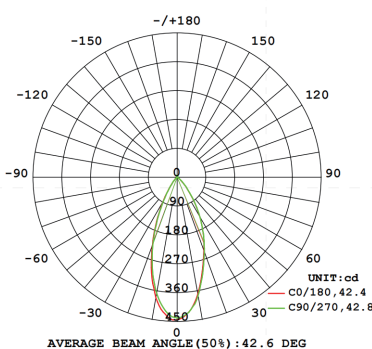

luminous intensity distribution diagram

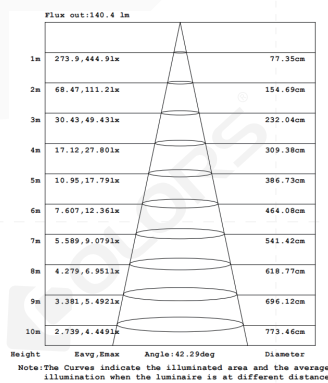

AAI Figure

[UGR]

ceiling/cavity	0.7	0.7	0.5	0.5	0.3	0.7	0.7	0.5	0.5	0.3	
walls	0.5	0.3	0.5	0.3	0.3	0.5	0.3	0.5	0.3	0.3	
working plane	0.2	0.2	0.2	0.2	0.2	0.2	0.2	0.2	0.2	0.2	
Room dimensions	Viewed crosswise					Viewed endwise					
x = 2H y = 2H	2H	12.8	13.4	13.1	13.6	13.8	13.1	13.6	13.3	13.8	14.0
	3H	12.7	13.3	13.0	13.5	13.8	13.0	13.5	13.3	13.8	14.0
	4H	12.7	13.2	13.0	13.4	13.7	12.9	13.4	13.2	13.7	14.0
	6H	12.6	13.1	12.9	13.4	13.7	12.8	13.3	13.2	13.6	13.9
	8H	12.5	13.0	12.9	13.3	13.6	12.8	13.3	13.2	13.6	13.9
	12H	12.5	13.0	12.9	13.3	13.6	12.8	13.2	13.1	13.5	13.9
4H	2H	12.8	13.3	13.1	13.5	13.8	13.0	13.5	13.3	13.8	14.0
	3H	12.6	13.1	13.0	13.4	13.7	12.9	13.3	13.3	13.7	14.0
	4H	12.5	12.9	12.9	13.3	13.7	12.8	13.2	13.2	13.6	13.9
	6H	12.4	12.8	12.9	13.2	13.6	12.7	13.1	13.1	13.4	13.9
	8H	12.4	12.7	12.8	13.2	13.6	12.6	13.0	13.1	13.4	13.8
	12H	12.4	12.7	12.8	13.1	13.6	12.6	12.9	13.1	13.3	13.8
8H	4H	12.4	12.7	12.8	13.1	13.6	12.6	13.0	13.1	13.4	13.8
	6H	12.3	12.6	12.8	13.0	13.5	12.5	12.8	13.0	13.3	13.7
	8H	12.2	12.5	12.7	13.0	13.5	12.5	12.7	13.0	13.2	13.7
	12H	12.2	12.4	12.7	12.9	13.5	12.4	12.7	13.0	13.2	13.7
12H	4H	12.3	12.6	12.8	13.1	13.5	12.6	12.9	13.0	13.3	13.8
	6H	12.2	12.5	12.7	12.9	13.5	12.5	12.7	13.0	13.2	13.7
	8H	12.2	12.4	12.7	12.9	13.4	12.4	12.6	12.9	13.1	13.7
Variations with the observer position at spacings:											
S = 1.0H	+ 2.2 / - 4.4					+ 2.2 / - 4.2					
1.5H	+ 2.2 / - 3.3					+ 2.0 / - 3.4					
2.0H	+ 4.5 / - 4.6					+ 4.6 / - 4.5					

CIE Pub.117, 285.3 lm Total Lamp Luminous Flux Correct ($8 \log(F/F_0) = -4.4$)

[Product mechanical data]

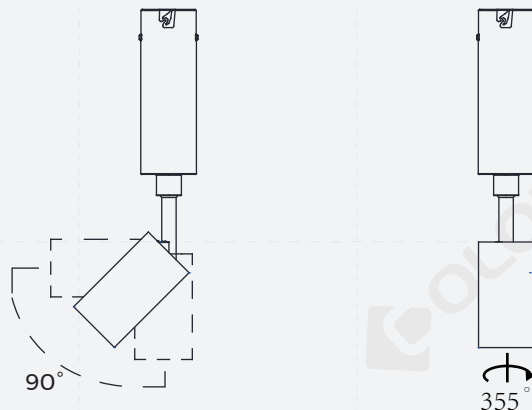

[Product Accessories Information]

Picture	Section size	Name	Description	Model	Note
		Base	Material: PC+ADC12 Input Voltage:DC48V Coating:Black,White Open Size: ϕ 45mm Rated Power:150W Rated Current:3A Certification:CE Warranty:5 years Maximum load: 8Kg/Lamp	RA-HR40(N)	
		Base	Material: PC+ADC12 Input Voltage:DC48V Coating:Black,White Open Size: ϕ 55mm Rated Power:150W Rated Current:3A Certification:CE Warranty:5 years Maximum load: 1Kg/Lamp	RA-HE40	
		Quick connector	Material:PA6 Size:L38*W9.4*H10.5mm [Inch Size: L1.5"*W0.37"*H0.41"] Applicable wires: solid wire:0.5-4mm ² stranded wire:0.5-2.5mm ² Rated Voltage:250V/600V Rated Current:32A Certification:CE Warranty:3 years	TB-02	
		Power supply	Dimming mode: Non-dimming Size:350*30*18mm Input voltage:AC220-240V Operating frequency: 50/60Hz PF value: \geq 0.9 Output voltage:48V Output current:2.1A Power:0-100W Efficiency:0.9	BN-V48-100P	
		Power supply	Dimming mode: Non-dimming Size:350*30*18mm Input voltage:AC220-240V Operating frequency: 50/60Hz PF value: \geq 0.95 Output voltage:48V Output current:3.125A Power:0-150W Efficiency:0.9	BN-V48-150P	Power supply Accessories
		Power supply	Dimming mode: Non-dimming Size:400*40*22mm Input voltage:AC220-240V Operating frequency: 50/60Hz PF value: \geq 0.95 Output voltage:48V Output current:5.12A Power:0-250W Efficiency:0.9	BN-V48-250P	

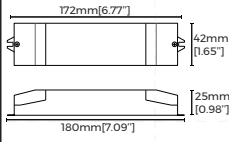
		<p>CASAMBI controller</p>	<p>Dimming mode: CASAMBI Size :180*42*25mm [Inch Size:7.09"*1.65"*0.98"] Input voltage :24-48VDC Output signal: DALI Output DALI Max.current: 250mA Control devices:≤64 Control groups:≤8 Certification:CE,UKCA Warranty:5 years</p>	<p>1200EN1612-CAS -0-0000003</p>	<p>Controller should be used with DALI dimming modules.</p>
--	--	---------------------------	---	---------------------------------------	---

Note:

1. Max. power cable (16AWG main cable) of base ≤ 50M
2. Total power of modules during work < 80%-85% output power of supply

[System]



[Packing]

Model	Size (mm/box)	Quantity /box	Quantity /carton	NW (kg/box)	NW (kg/carton)	GW (kg)	Size (mm/carton)
FD-HM40S1830(N)-N940B04	180*110*48 (7.1"*4.3"*1.9")	1	30	0.14	4.2	6.95	390*360*270 (15.4"*14.2"*10.6")

[Attentions]

- 1、 Non-professionals are prohibited from installing, disassembling and repairing the product.
- 2、 Avoid scratching, distortion and irregular bending of the product during installation; otherwise it may cause irreparable damage to the product.
- 3、 Please use professional cutting tools when cutting.
- 4、 Do not use any acid or alkaline adhesive to fix products.
- 5、 The product is only suitable for indoor dry places, can not be used in outdoor, seaside or wet environment.
- 6、 PC features: Each 10°C rise or drop will make diffuser extend or shrink 0.8mm/m, please confirm before processing and use.
- 7、 The insertion and removal of the base and lighting module shall not exceed 50 times.