

**Free-Dot System Specification**

# HM40CD

— HOLA series



## 【Basic Parameters】

- Installation: Ceiling
- Material: AL6063-T5
- Coating: Black/White(Customizable) optional
- Dimming method: Non/DALI-2/CASAMBI
- Input voltage: DC48V
- SDCM: <3 Step (ANSI)
- CRI: 90
- CCT: 2700/3000/4000K optional
- Beam angle: 200°x110°
- Application: Indoor
- IP grade: IP20
- Warranty: 5 years
- Certification: CE、UKCA、ETL、ROHS、Reach

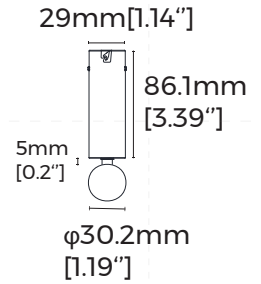

## 【Luminaire Parameters】

Version	Model	Length	Input Voltage (V)	Max. Current (A)	Type Power (W)	Max. Power (W)	CRI	CCT	Lumen (LM)
Normal	HM40CD	604mm [1.98']	DC48V	0.250	12	12	>90	2700K	1092 [552LM/ft]
								3000K	1128 [570LM/ft]
								4000K	1200 [606LM/ft]
		904mm [2.97']		2700K	1638 [552LM/ft]				
				3000K	1692 [570LM/ft]				
				4000K	1800 [606LM/ft]				
		1204mm [3.95']		2700K	2184 [552LM/ft]				
				3000K	2256 [570LM/ft]				
				4000K	2400 [606LM/ft]				

Note:

1. The above parameters were tested based on Ra90, 4000K, light source;
2. luminous flux is allowed to have a ±10% error range;
3. The above parameters are typical values.

**[Optical Parameter]**

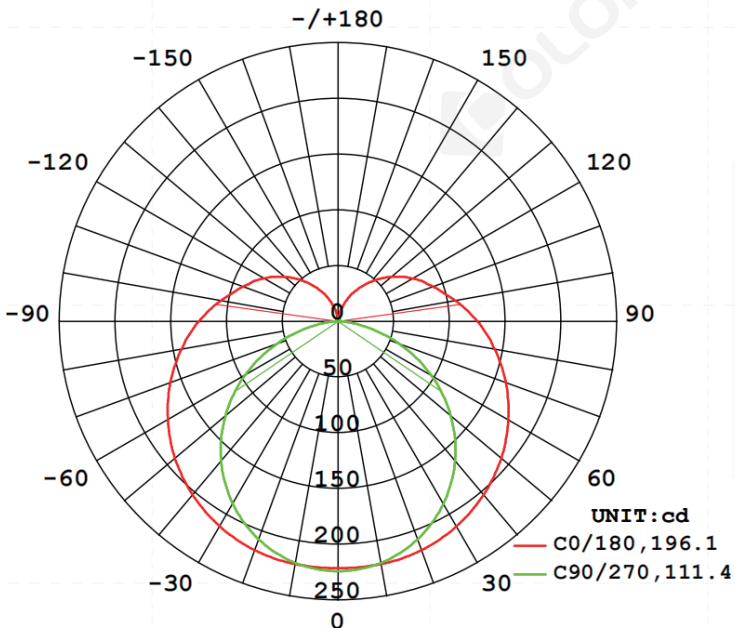

luminous intensity distribution diagram

Flux out: 519.1 lm

Height	Eavg, Emax	Angle: 111.44deg	Diameter
1m	75.18, 224.21lx		293.43cm
2m	18.79, 56.05lx		586.86cm
3m	8.353, 24.91lx		880.29cm
4m	4.699, 14.01lx		1173.72cm
5m	3.007, 8.967lx		1467.15cm
6m	2.088, 6.227lx		1760.58cm
7m	1.534, 4.575lx		2054.01cm
8m	1.175, 3.503lx		2347.44cm
9m	0.9281, 2.768lx		2640.87cm
10m	0.7518, 2.242lx		2934.29cm





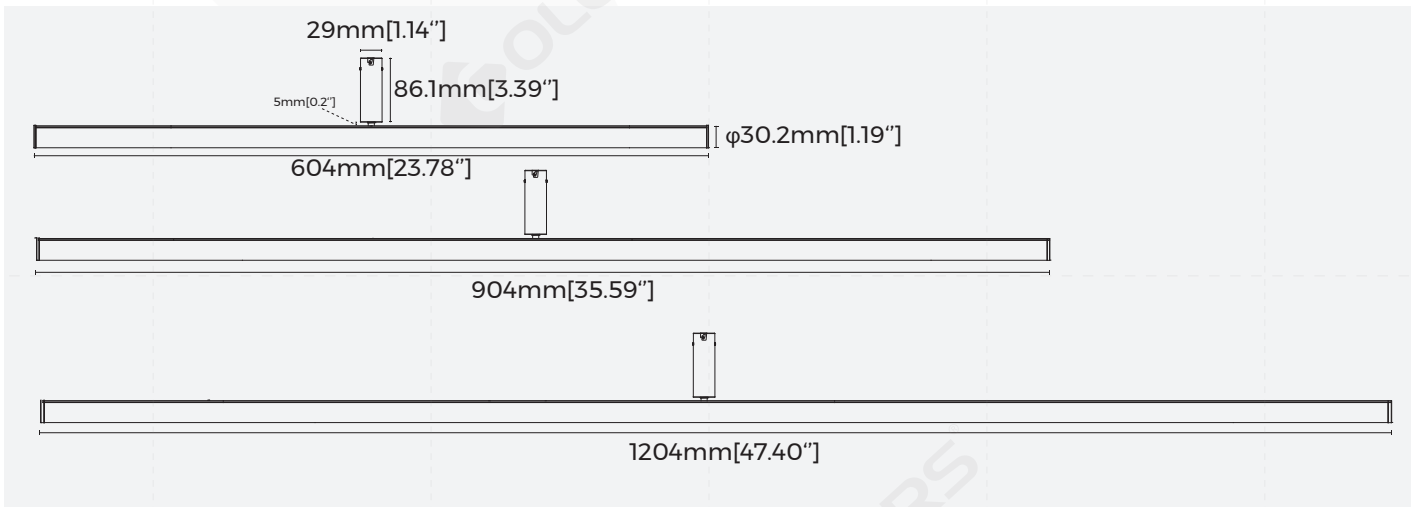

Note: The Curves indicate the illuminated area and the average illumination when the luminaire is at different distance.

AAI Figure

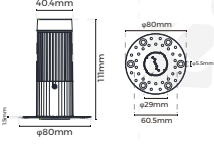
**[Product mechanical data]**

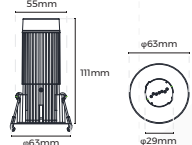
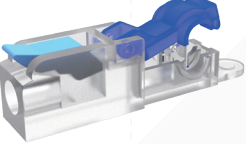
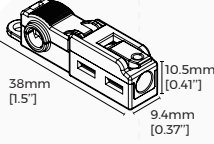

## [Product Accessories Information]

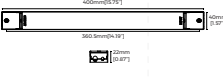
Picture	Section size	Name	Description	Model	Note
		Base	Material: PC+ADC12 Input Voltage:DC48V Coating:Black,White Open Size: $\phi$ 45mm Rated Power:150W Rated Current:3A Certification:CE Warranty:5 years Maximum load: 8Kg/Lamp	RA-HR40(N)	
		Base	Material: PC+ADC12 Input Voltage:DC48V Coating:Black,White Open Size: $\phi$ 55mm Rated Power:150W Rated Current:3A Certification:CE Warranty:5 years Maximum load: 1Kg/Lamp	RA-HE40	
		Quick connector	Material:PA6 Size:L38*W9.4*H10.5mm [Inch Size: L1.5"*W0.37"*H0.41"] Applicable wires: solid wire:0.5-4mm <sup>2</sup> stranded wire:0.5-2.5mm <sup>2</sup> Rated Voltage:250V/600V Rated Current:32A Certification:CE Warranty:3 years	TB-02	
		Power supply	Dimming mode: Non-dimming Size:350*30*18mm Input voltage:AC220-240V Operating frequency: 50/60Hz PF value: $\geq$ 0.9 Output voltage:48V Output current:2.1A Power:0-100W Efficiency:0.9	BN-V48-100P	
		Power supply	Dimming mode: Non-dimming Size:350*30*18mm Input voltage:AC220-240V Operating frequency: 50/60Hz PF value: $\geq$ 0.95 Output voltage:48V Output current:3.125A Power:0-150W Efficiency:0.9	BN-V48-150P	Power supply Accessories
		Power supply	Dimming mode: Non-dimming Size:400*40*22mm Input voltage:AC220-240V Operating frequency: 50/60Hz PF value: $\geq$ 0.95 Output voltage:48V Output current:5.12A Power:0-250W Efficiency:0.9	BN-V48-250P	

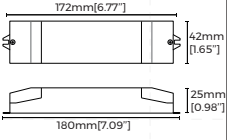
		<p>CASAMBI controller</p>	<p>Dimming mode: CASAMBI  Size :180*42*25mm  [Inch Size:7.09"*1.65"*0.98"]  Input voltage :24-48VDC  Output signal: DALI  Output DALI Max.current:  250mA  Control devices:≤64  Control groups:≤8  Certification:CE,UKCA  Warranty:5 years</p>	<p>1200EN1612-CAS  -0-0000003</p>	
--	---	---------------------------	--	---------------------------------------	--

Note:

1. Max. power cable (16AWG main cable) of base ≤ 50M
2. Total power of modules during work < 80%-85% output power of supply

## [System]



## [Packing]

Model	Size (mm/box)	Quantity /box	Quantity /carton	NW (kg/box)	NW (kg/carton)	GW (kg)	Size (mm/carton)
FD-HM40CD0600-N940B12	35*135*610 (1.38"*5.31"*24")	1	15	0.26	3.9	5.7	630*417*195 (24.8"*16.4"*7.7")
FD-HM40CD0900-N940B18	35*135*910 (1.38"*5.31"*35.8")	1	15	0.32	4.8	7.2	930*417*195 (36.6"*16.4"*7.7")
FD-HM40CD1200-N940B24	35*135*1210 (1.38"*5.31"*47.6")	1	15	0.4	6	9.8	1230*417*195 (48.4"*16.4"*7.7")

## [Attentions]

- 1、 Non-professionals are prohibited from installing, disassembling and repairing the product.
- 2、 Avoid scratching, distortion and irregular bending of the product during installation; otherwise it may cause irreparable damage to the product.
- 3、 Please use professional cutting tools when cutting
- 4、 Do not use any acid or alkaline adhesive to fix products
- 5、 The product is only suitable for indoor dry places, can not be used in outdoor, seaside or wet environment.
- 6、 PC features: Each 10°C rise or drop will make diffuser extend or shrink 0.8mm/m, please confirm before processing and use
- 7、 The insertion and removal of the base and lighting module shall not exceed 50 times.