

Free-Dot System Specification

HH40FD

— HOLA series



【Basic Parameters】

- Installation: Pendant
- Size: 25*100*1200/1500/1800/2400mm
- Material: AL6063-T5
- Coating: Black/White(Customizable) optional
- Dimming method: Non/DALI-2/CASAMBI
- Input voltage: DC48V
- SDCM: <3 Step (ANSI)
- CRI: 90
- CCT: 2700/3000/4000K optional
- Beam angle: Up:100°,Down:100°
- Application: Indoor
- IP grade: IP20
- Warranty: 5 years
- Certification: CE、UKCA、ETL、ROHS、Reach

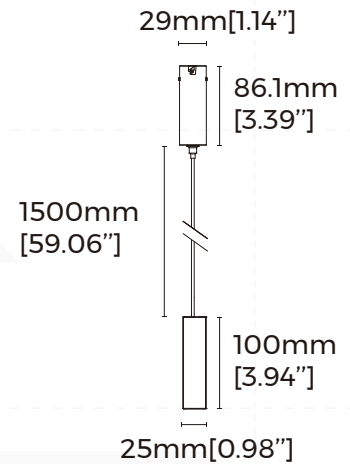
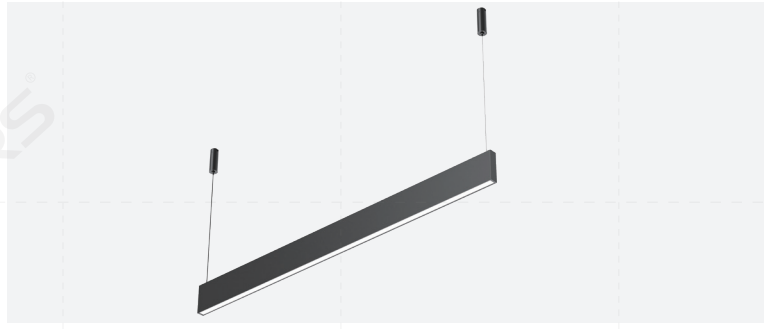

【Luminaire Parameters】

Version	Model	Length	Input Voltage (V)	Max. Current (A)	Type Power (W)	Max. Power (W)	CRI	CCT	Lumen (LM)
Normal	HH40FD	1208mm [3.96']	DC48V	1	48	48	>90	2700K	2640 [667LM/ft]
								3000K	2688 [679LM/ft]
								4000K	2880 [727LM/ft]
		1508mm [4.95']		2700K	3300 [667LM/ft]				
				3000K	3360 [679LM/ft]				
				4000K	3600 [727LM/ft]				
		1808mm [5.93']		2700K	3960 [667LM/ft]				
				3000K	4032 [679LM/ft]				
				4000K	4320 [727LM/ft]				
		2408mm [7.90']		2700K	5280 [667LM/ft]				
				3000K	5376 [679LM/ft]				
				4000K	5760 [727LM/ft]				

Note:

1. The above parameters were tested based on Ra90, 4000K, light source;
2. luminous flux is allowed to have a ±10% error range;
3. The above parameters are typical values.

[Optical Parameter]

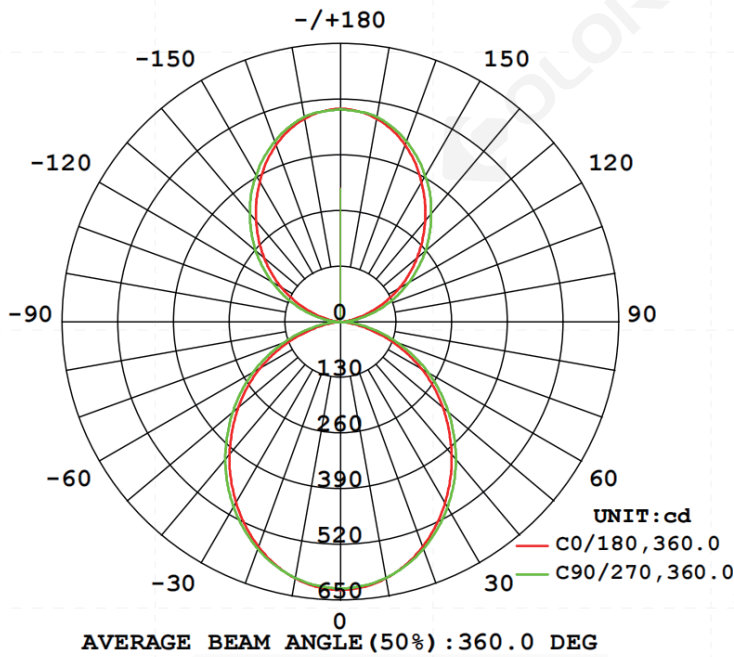

luminous intensity distribution diagram

Flux out: 1038 lm

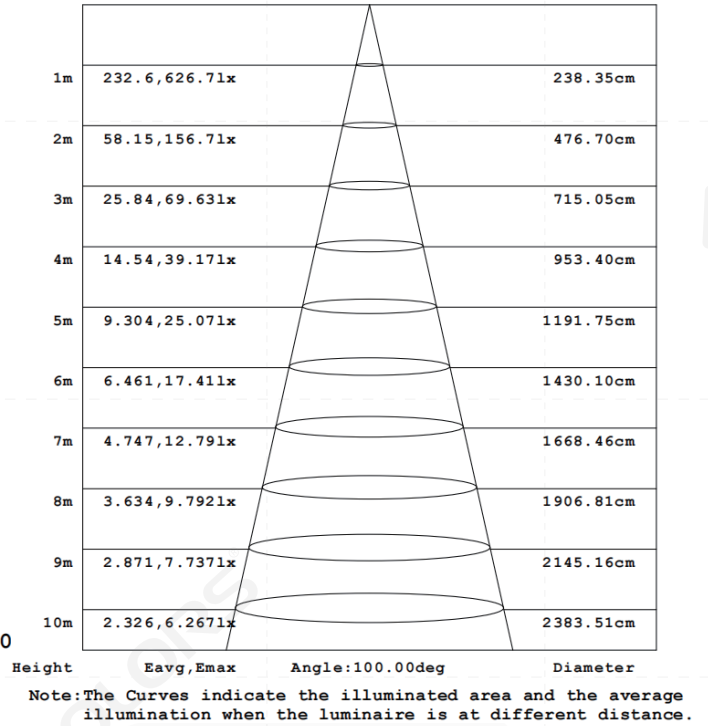

AAI Figure

[Product mechanical data]

· Normal

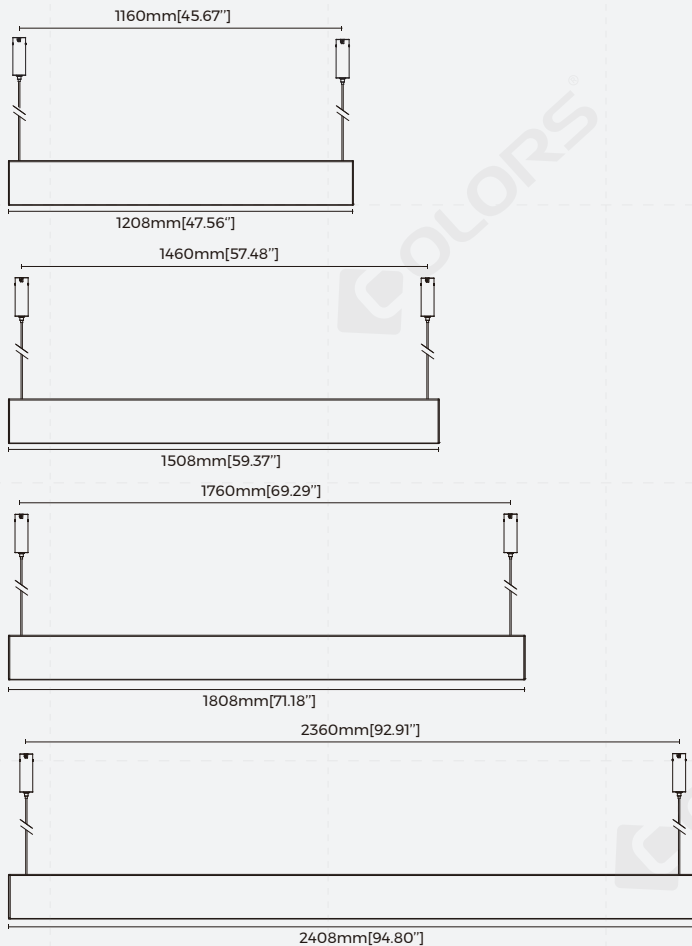

[Product Accessories Information]

Picture	Section size	Name	Description	Model	Note
		Base	Material: PC+ADC12 Input Voltage:DC48V Coating:Black,White Open Size: ϕ 45mm Rated Power:150W Rated Current:3A Certification:CE Warranty:5 years Maximum load: 8Kg/Lamp	RA-HR40(N)	
		Base	Material: PC+ADC12 Input Voltage:DC48V Coating:Black,White Open Size: ϕ 55mm Rated Power:150W Rated Current:3A Certification:CE Warranty:5 years Maximum load: 1Kg/Lamp	RA-HE40	
		Quick connector	Material:PA6 Size:L38*W9.4*H10.5mm [Inch Size: L1.5"*W0.37"*H0.41"] Applicable wires: solid wire:0.5-4mm ² stranded wire:0.5-2.5mm ² Rated Voltage:250V/600V Rated Current:32A Certification:CE Warranty:3 years	TB-02	
		Power supply	Dimming mode: Non-dimming Size:350*30*18mm Input voltage:AC220~240V Operating frequency: 50/60Hz PF value: \geq 0.9 Output voltage:48V Output current:2.1A Power:0-100W Efficiency:0.9	BN-V48-100P	
		Power supply	Dimming mode: Non-dimming Size:350*30*18mm Input voltage:AC220~240V Operating frequency: 50/60Hz PF value: \geq 0.95 Output voltage:48V Output current:3.125A Power:0-150W Efficiency:0.9	BN-V48-150P	Power supply Accessories
		Power supply	Dimming mode: Non-dimming Size:400*40*22mm Input voltage:AC220~240V Operating frequency: 50/60Hz PF value: \geq 0.95 Output voltage:48V Output current:5.12A Power:0-250W Efficiency:0.9	BN-V48-250P	

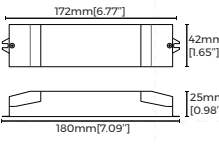
		<p>CASAMBI controller</p>	<p>Dimming mode: CASAMBI Size :180*42*25mm [Inch Size:7.09"*1.65"*0.98"] Input voltage :24-48VDC Output signal: DALI Output DALI Max.current: 250mA Control devices:≤64 Control groups:≤8 Certification:CE,UKCA Warranty:5 years</p>	<p>1200EN1612-CAS -0-0000003</p>	<p>Controller should be used with DALI dimming modules.</p>
--	---	---------------------------	---	---	---

Note:

1. Max. power cable (16AWG main cable) of base ≤ 50M
2. Total power of modules during work < 80%-85% output power of supply

[System]



[Packing]

Model	Size (mm/box)	Quantity /box	Quantity /carton	NW (kg/box)	NW (kg/carton)	GW (kg)	Size (mm/carton)
FD-HH40FD1200-N940B48	35*135*1210 (1.38**5.31**47.64")	1	4	1.7	6.8	9	1230*290*100 (48.4**11.4**3.9")
FD-HH40FD1500-N940B60	35*135*1510 (1.38**5.31**59.45")	1	4	2.1	8.4	10.2	1530*290*100 (60.2**11.4**3.9")
FD-HH40FD1800-N940B72	35*135*1810 (1.38**5.31**71.26")	1	4	2.61	10.44	12.8	1830*290*100 (72**11.4**3.9")
FD-HH40FD2400-N940B96	35*135*2410 (1.38**5.31**94.88")	1	4	3.22	12.88	15.2	2430*290*100 (95.7**11.4**3.9")

[Attentions]

- 1、 Non-professionals are prohibited from installing, disassembling and repairing the product.
- 2、 Avoid scratching, distortion and irregular bending of the product during installation; otherwise it may cause irreparable damage to the product.
- 3、 Please use professional cutting tools when cutting.
- 4、 Do not use any acid or alkaline adhesive to fix products.
- 5、 The product is only suitable for indoor dry places, can not be used in outdoor, seaside or wet environment.
- 6、 PC features: Each 10°C rise or drop will make diffuser extend or shrink 0.8mm/m, please confirm before processing and use.
- 7、 The insertion and removal of the base and lighting module shall not exceed 50 times.