

Downlight Specification

BR75L2

— **Brook series**



◎ Basic Parameters

- Material: ADC12, spraying surface
- Driver Installation: Remote
- IP grade: IP65
- CCT: 2700/3000/3500/4000K optional
- CRI: 90
- SDCM(Light source): <3 Step (ANSI)
- Beam angle: 15°/24°/36°/45° optional
- UGR(X=4H,Y=8H): ≤6(15°/24°/36°), ≤16(45°)
- Lighting direction: Downward
- Dimming method: Non / 1-10V / DALI optional
- Input voltage: AC220-240V
- Working temperature: -15°C~30°C
- Application: Indoor/outdoor
- Installation: Trimless Recessed
- Certification: CE, ROHS, Reach
- Warranty: 5 years



◎ Frame Color



White

◎ Reflector type

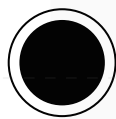

Matte black



Matte white



Mirror



Black chrome

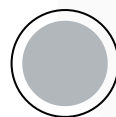

Matte Silver

◎ Optical Accessory



Honeycomb

◎ Product mechanical data

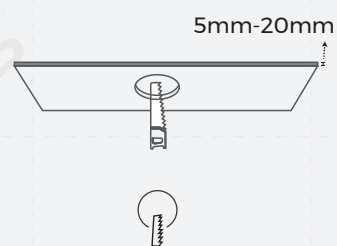
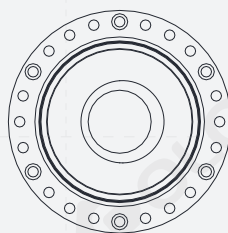
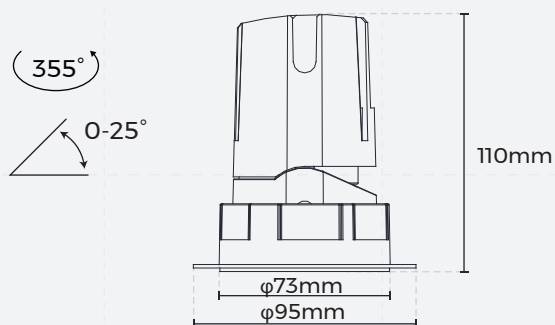

Opening size: φ75mm

◎Luminaire Parameters

Model	Size (mm)	Opening (mm)	Input	Power.tpy (W)	CRI	CCT	Beam Angle	Lumen (LM)
BR75L2	φ95*110	φ75	36V/300mA	12	>90	3000K	15°	500
							24°	720
							36°	745
							45°	625
BR75L2	φ95*110	φ75	36V/350mA	15	>90	3000K	24°	870
							36°	900
							45°	750

Note:

1. The above parameters were tested based on Ra90, 3000K, light source;

2700K Light efficiency & Luminous flux=3000K*0.95

3500K Light efficiency & Luminous flux=3000K*1.05

4000K Light efficiency & Luminous flux=3000K*1.08

2. The input voltage and input current belong to the light source.

3. luminous flux is allowed to have a ±10% error range;

4. The above parameters are typical values.

5. Note: If the "Honeycomb" is selected, it will be installed on the spotlight by default, and the parameters will change as follows.

- Spotlights with beam angles of "15°", "24°" and "36°": the light efficiency will be reduced by 30%, the beam Angle will be reduced by 12%, the anti-glare effect will be better, and the UGR will be reduced by 40%.

- Spotlights with beam angles of "45°": the light efficiency will be reduced by 50%, the beam Angle will be reduced by 25%, the anti-glare effect will be better, and the UGR will be reduced by 40%.

◎Optical Parameter

· Type Power:12W

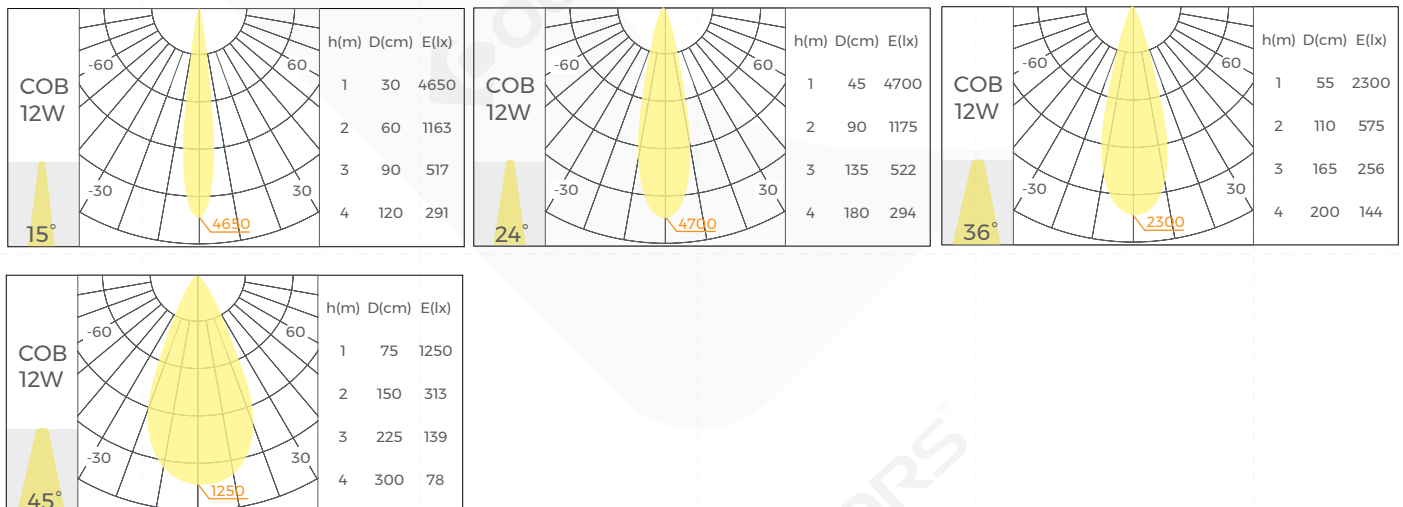

• Type Power:15W

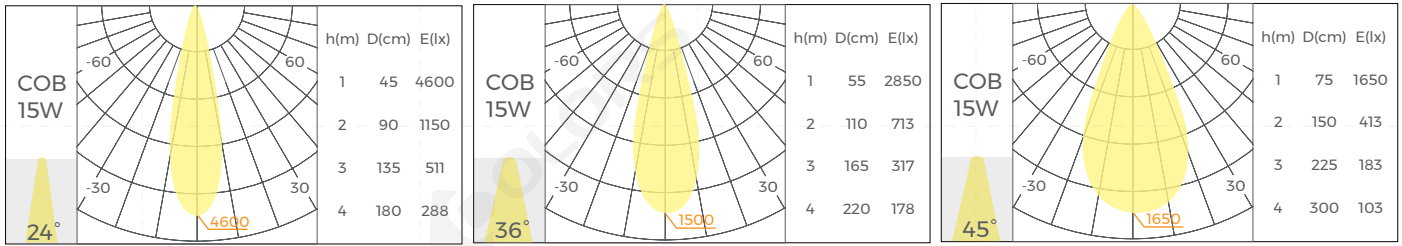

Note:

1. Central light intensity value = 1 meter maximum luminous intensity value;
 1. N meter maximum luminous intensity value = Central light intensity value/N²;
- For example: 2 meter maximum luminous intensity value = Central light intensity value/2²;

◎Packing

Model	Size (mm/box)	Quantity /box	Quantity /carton	NW (kg/box)	NW (kg/carton)	CW (kg)	Size (mm/carton)
DL-BR75L2-XXX	165*125*150	1	20	0.8	16	20.5	645*345*315

◎Model Code

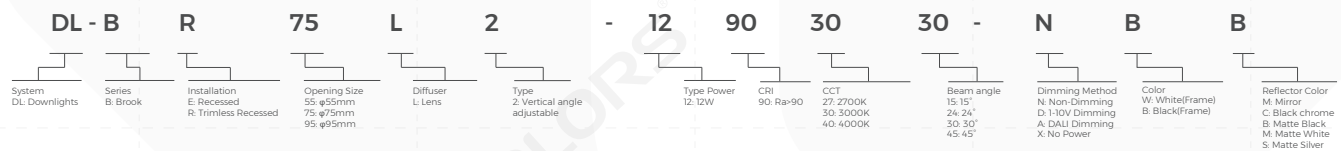

◎Attentions

1. Non-professionals are prohibited from installing, disassembling and repairing the product.
2. Avoid scratching, distortion and irregular bending of the product during installation; otherwise it may cause irreparable damage to the product.
3. Please use professional cutting tools when cutting.
4. Do not use any acid or alkaline adhesive to fix products.