

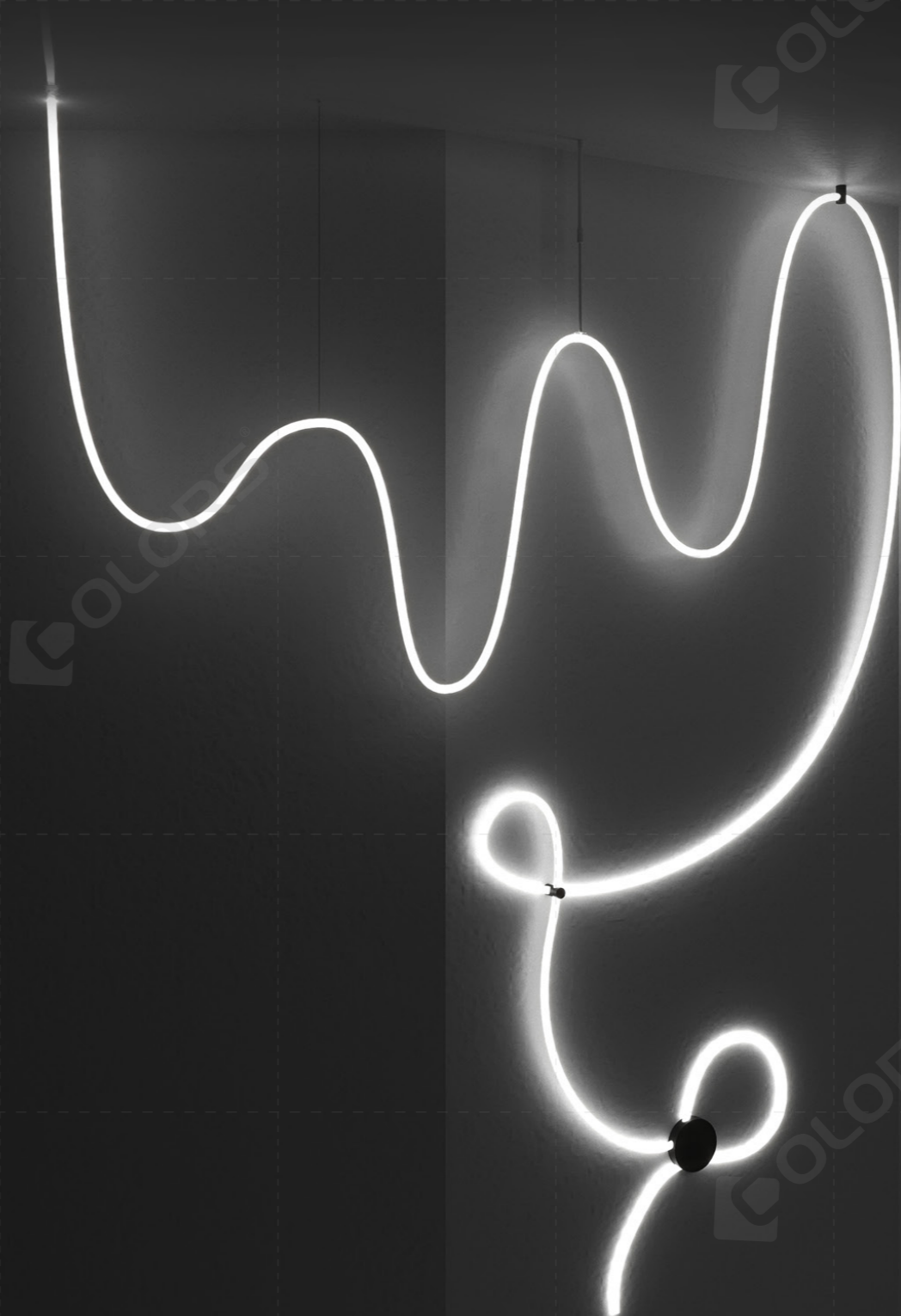

360 NEON Design Manual

FLEXIBLE SERIES

Φ13/18/25/40mm



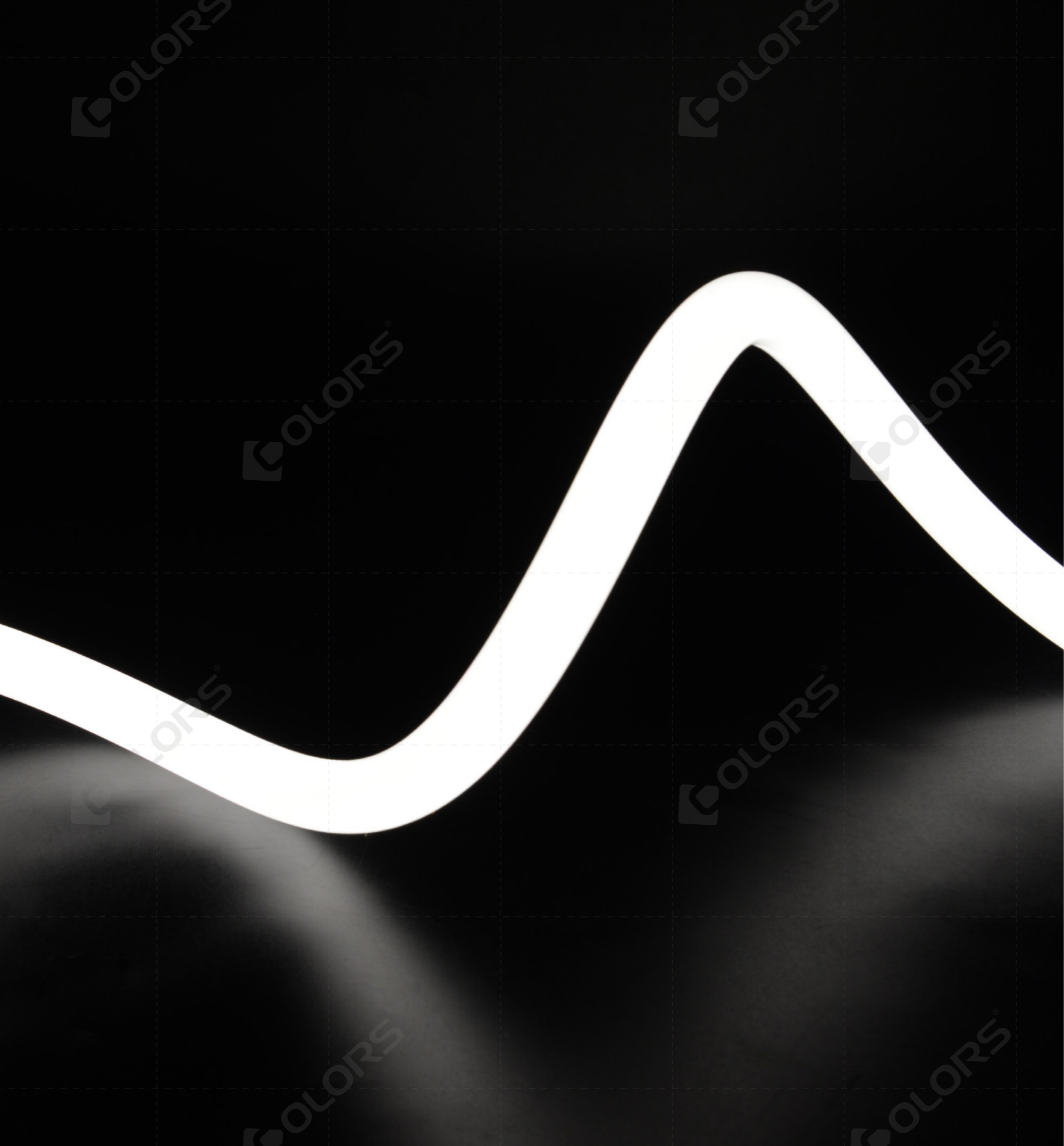

Flexible Series

Magic Line

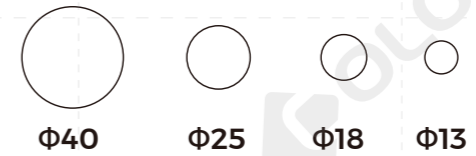

- 360° omnidirectional illumination
- Freely bendable for shaping
- Free cutting (selected models)
- Diverse dimensions, comprehensive installation solutions, complete light color selections

360° Omnidirectional Illumination

Round silicone neon design delivers seamless circular illumination without dark spots.

It offers comfortable visual effect, high luminous efficacy and no dark areas.

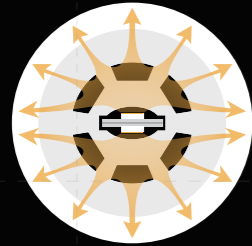

Light Emission Diagram



Freely Twisted for Shapes

Arbitrarily bendable for shaping;

Realize bold and creative designs tailored to project or user requirements.



Free Cutting

Brings convenience to installation and design.



*Free cutting applicable for White Light/RGB-SPI models



Abundant Sizes & Complete Light Color Configurations



Accessory Solutions

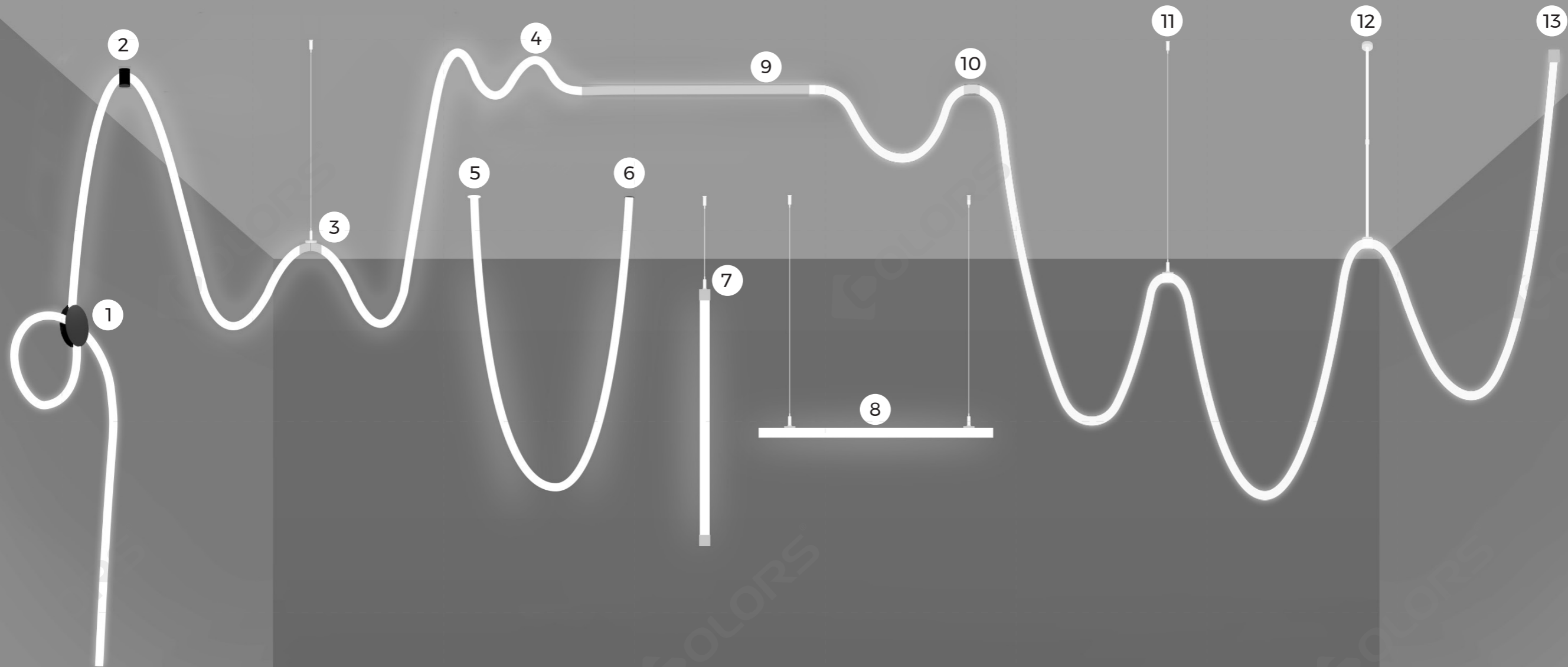

① Round Plate



② Piece Cylinder



③ Head-to-head Connector



④ Invisible Fastener



⑤ Edge Embedding



⑥ Boundless Embedding



⑦ Vertical Lifting



⑧ Horizontal Suspension



⑨ Transparent PC Slot



⑩ Transparent PC Clip



⑪ Suspension Rope



⑫ Extensible Boom



⑬ Ceiling Mounted



NNR40 Shaping Solutions

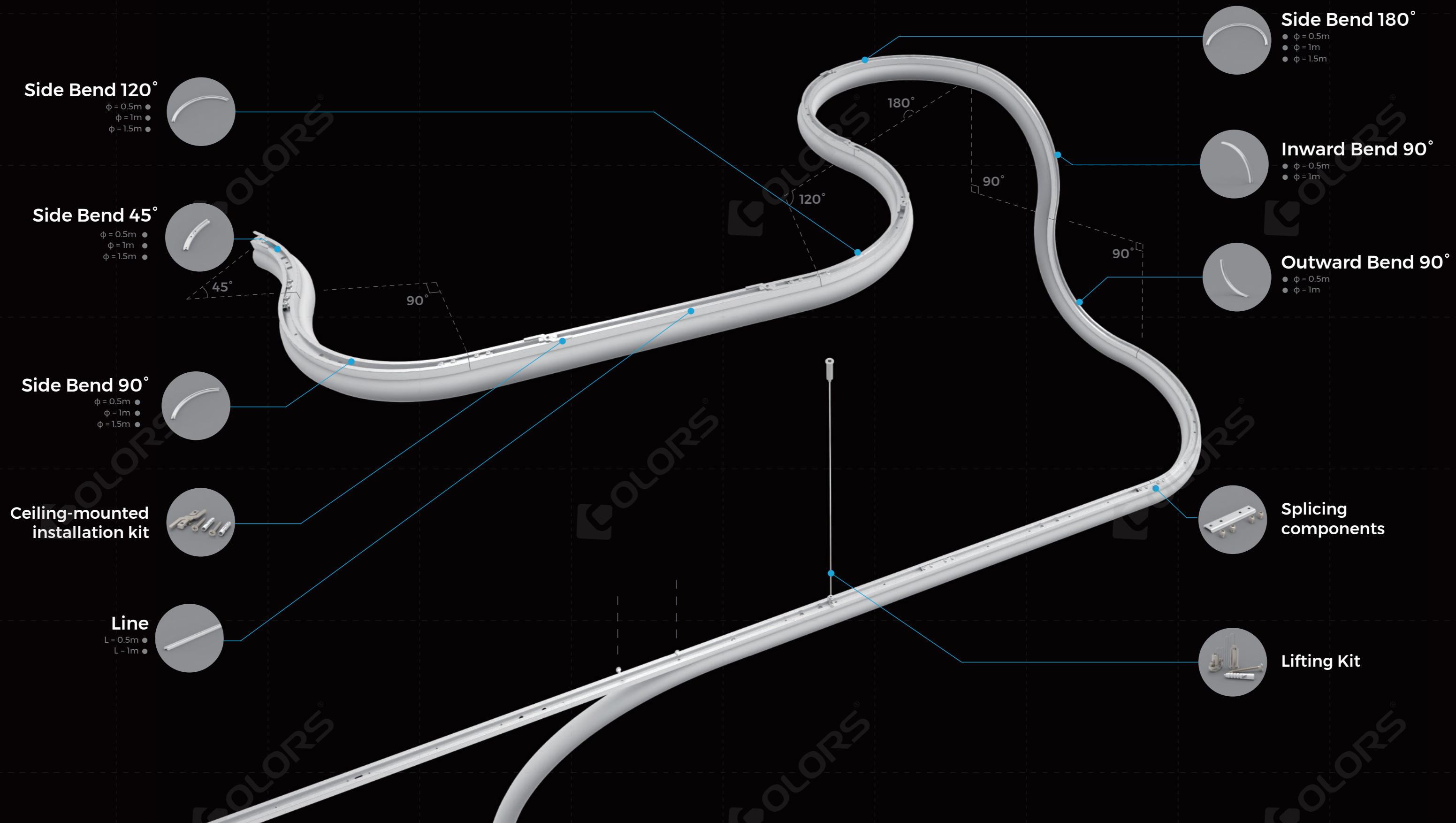



Residential Living Room

This is a 5-15 m² small and medium-sized residential leisure space, with the core demand to create a relaxed and warm home atmosphere. Flexible neon is bent and arranged along the wall with 360° uniform luminance, which not only serves as decorative wall lines to enhance spatial artistry, but also supplements ambient light, making the living room both aesthetically pleasing and comfortable.

Recommended Models

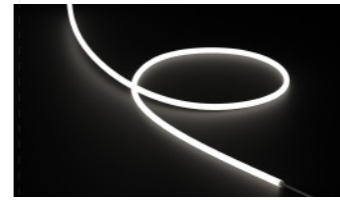

NNR13

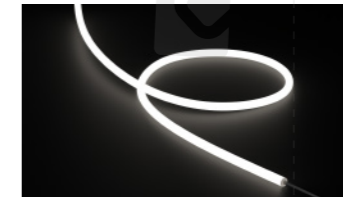

NNR18



NNR25

Recommended Reasons

1. Space-saving and non-destructive to decoration style, seamlessly integrating with modern minimalist, wabi-sabi and other home styles, balancing decorativeness and spatial neatness.

2. 360° soft illumination creates a relaxed and warm atmosphere for family leisure and dining interaction.

3. Supports free cutting (certain models) and flexible bending; custom shapes can be made according to soft decoration layout with strong creative adaptability, enabling personalized light and shadow design without professional designers.

Mounting Methods

1 Applicable Models: NNR13/ NNR18/ NNR25

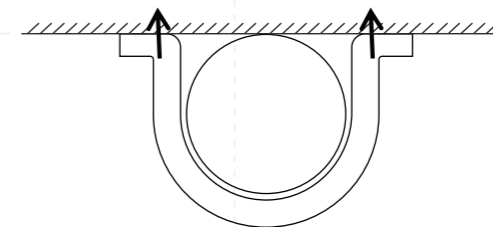

Transparent PC Clip



Applicable Models: NNR25

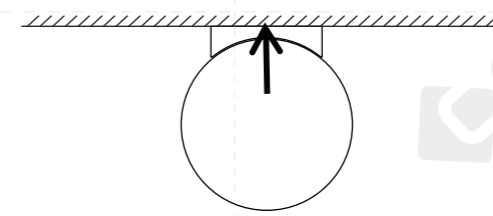

Invisible Fastener



2 Applicable Models: NNR13/ NNR18/ NNR25

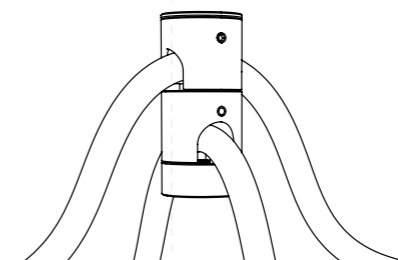

Piece Cylinder

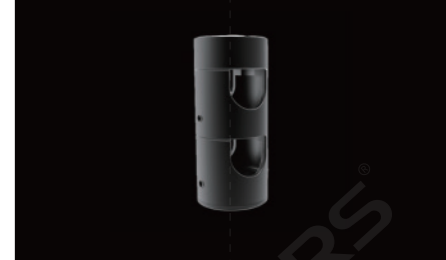

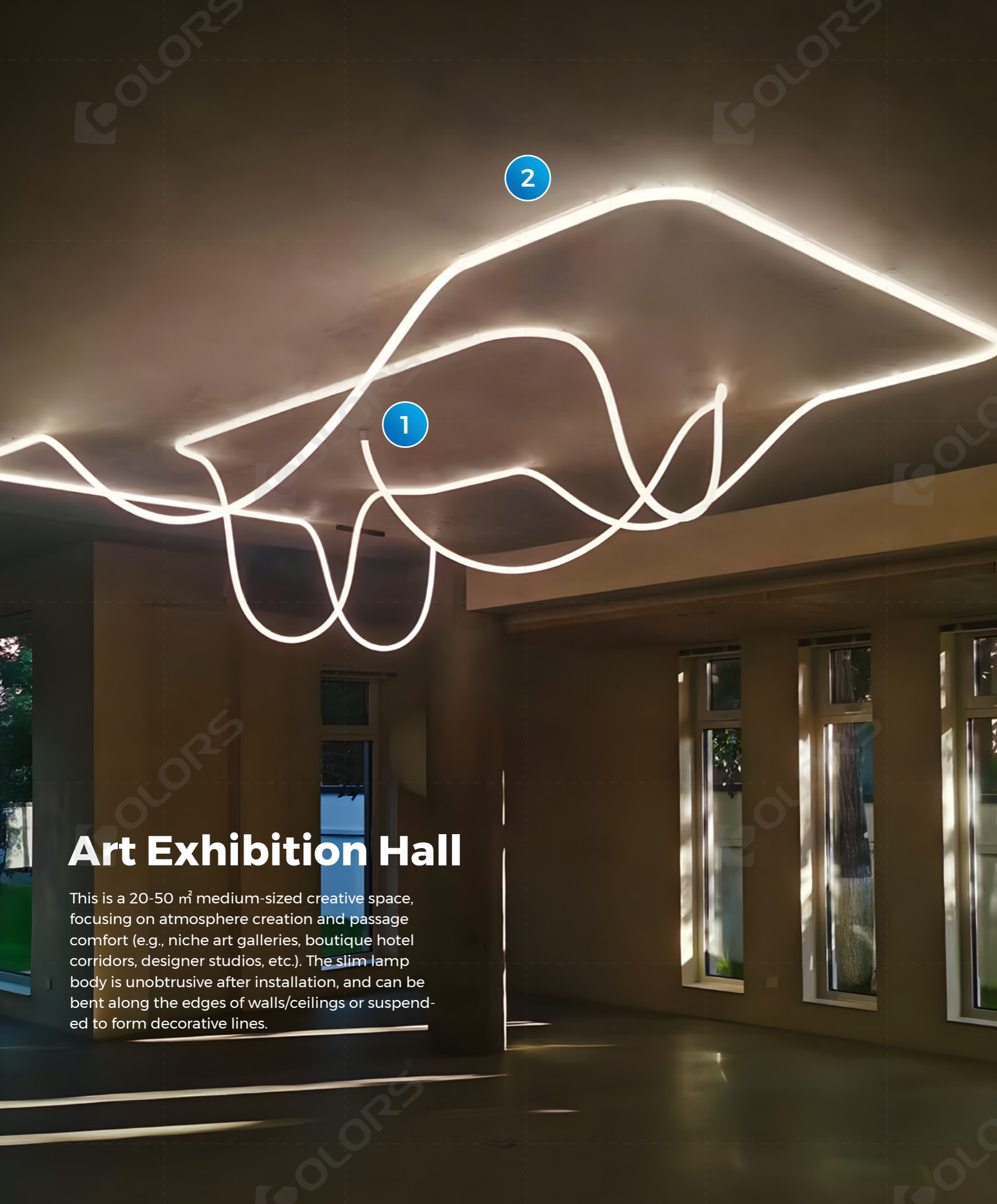

Art Exhibition Hall

This is a 20-50 m² medium-sized creative space, focusing on atmosphere creation and passage comfort (e.g., niche art galleries, boutique hotel corridors, designer studios, etc.). The slim lamp body is unobtrusive after installation, and can be bent along the edges of walls/ceilings or suspended to form decorative lines.

Recommended Models

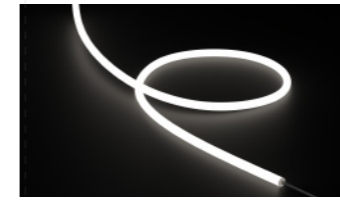

NNR18



NNR25



NNR40

Recommended Reasons

1. Glare-free illumination and 3D shaping capability create immersive light and shadow installations that become the visual focus of the space, aligning with the avant-garde design positioning of art venues.

2. Soft and layered light enhances the tranquility and premium feel of the artistic atmosphere, guiding the audience to focus on exhibits and spatial experience.

3. Slim lamp body + concealed installation do not block exhibits or damage spatial integrity, making light and shadow echo with art exhibits and architectural structures to improve the aesthetic recognition of the venue.

Mounting Methods

1 Applicable Models: NNR18/ NNR25/ NNR40

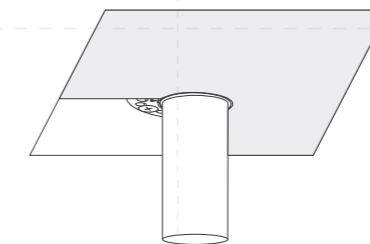

Applicable Models: NNR18/ NNR25/ NNR40

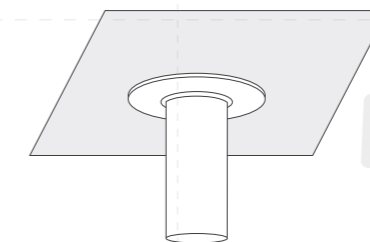

2 Applicable Models: NNR18/ NNR25/ NNR40

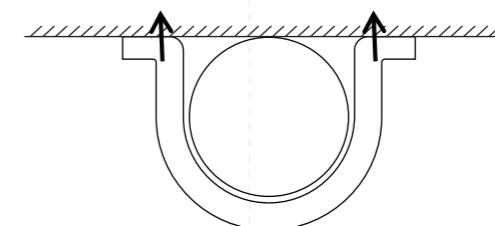

Boundless Embedding

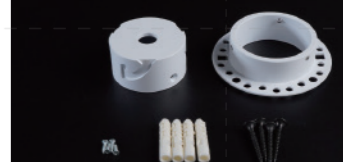

Edge Embedding



Transparent PC Slot





High-Rise Area of Clubhouse

This is a 50-200 m² medium and large leisure social space, the double-height public area of high-end clubhouses, featuring a double-height and open layout (with leisure tables and chairs, open bar). The core demand is to create a spatial visual focus and a high-end, relaxed social atmosphere. Flexible neon not only serves as an artistic installation to enhance design texture, but also fills the visual emptiness of high ceilings, making the open space both aesthetically distinctive and comfortable for socializing.

Recommended Models

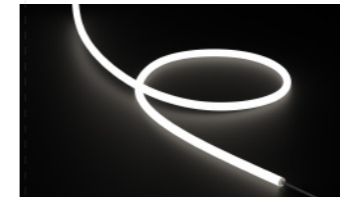

NNR18



NNR25



NNR40

Recommended Reasons

1.Soft light effect seamlessly integrates with modern minimalist decoration to maintain a unified spatial tone; flexible model selection according to regional needs balances overall aesthetic texture and lighting intensity requirements of different zones.

2.Features the advantage of "light renovation" installation: no occupation of wall or ground space, and no damage to the original decoration structure during installation, enabling rapid light and shadow upgrading without affecting the daily operation rhythm of the clubhouse.

3.In high and open areas, it can form a visual core to naturally guide the gathering of people's moving lines; at the same time, 360° soft light avoids the sense of oppression from strong light, perfectly fitting the commercial atmosphere.

Mounting Methods

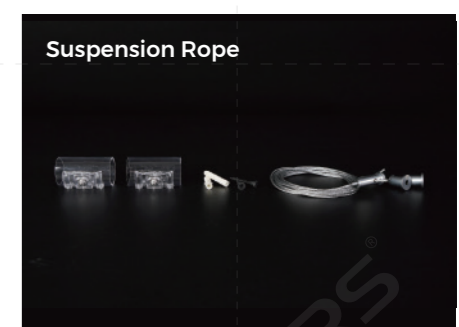
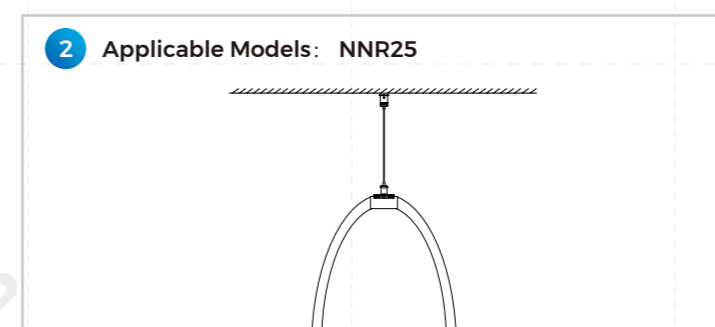
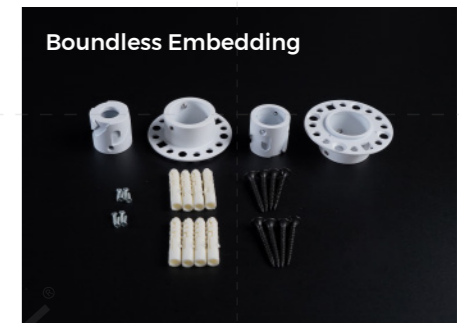
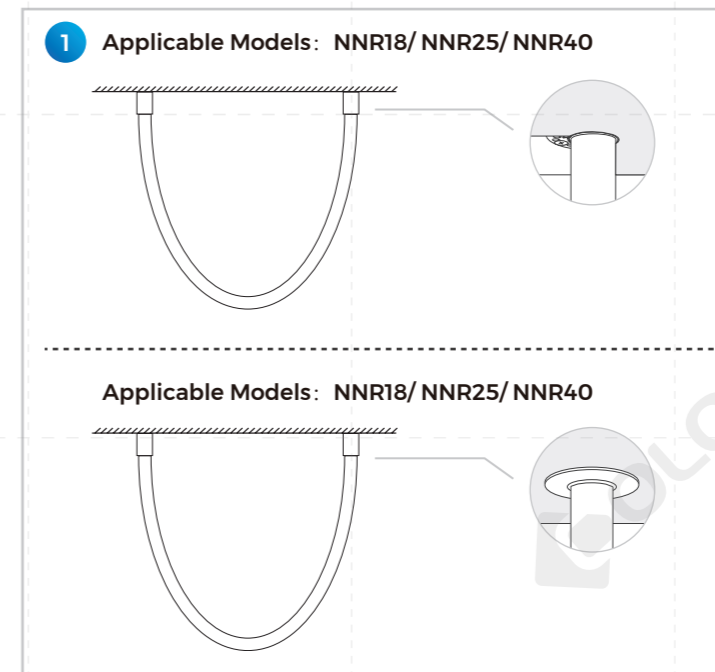

*For NNR40 with double-ended hanging, frameless or flanged embedded installation is recommended, with built-in safety ropes in the embedded parts.



Modern Commercial Corridor

This is a 50-200 m² large commercial public corridor, commonly found in office building lobbies, commercial complex entrances and other places, with metal strip grille ceilings and large glass curtain walls as the hard decoration base. Curved light sources are used for embellishment to enhance the modern sense. Its core function is to serve as a transition space for people's passage, with a simple and transparent overall atmosphere, aligning with the efficient and minimalist positioning of modern commer-

Recommended Models



NNR25



NNR40

Recommended Reasons

1.Soft light effect seamlessly integrates with modern minimalist decoration to maintain a unified spatial tone; flexible model selection according to regional needs balances overall aesthetic texture and lighting intensity requirements of different zones.

2.Features the advantage of "light renovation" installation: no occupation of wall or ground space, and no damage to the original decoration structure during installation, enabling rapid light and shadow upgrading without affecting the daily operation rhythm of the clubhouse.

Mounting Methods

Applicable Models: NNR25/NNR40

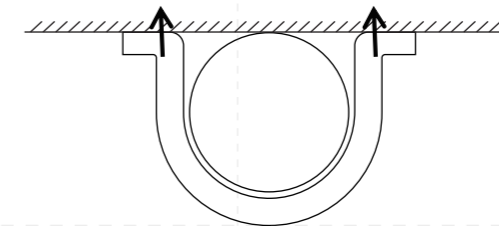

Applicable Models: NNR25

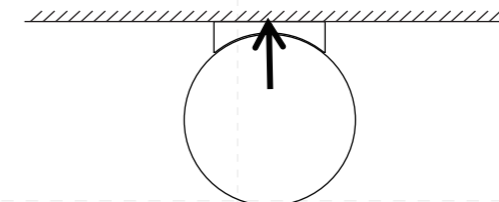

Applicable Models: NNR40

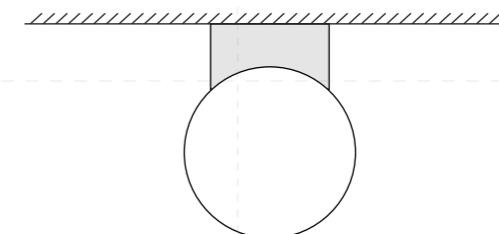

Transparent PC Clip

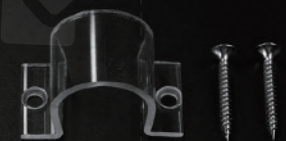

Invisible Fastener



Bending Profile



Splicing Components



Ceiling-mounted Installation Kit





Art Gallery Corner

This is a 10-50 m² medium art gallery display area, the corridor-style transition display area of cultural and creative exhibition halls and boutique spaces. The core demand is to create an artistic atmosphere and guide visitor flow through curved light sources. NNR40 is bent into smooth curves along the walls and ceilings, which not only serves as wall and ceiling artistic decoration to enhance the spatial style, but also softly illuminates the corridor and naturally guides the moving lines.

Recommended Models



NNR40

Recommended Reasons

1. Glare-free illumination and 3D shaping capability create immersive light and shadow installations that become the visual focus of the space, aligning with the avant-garde design positioning of art venues.
2. Soft and layered light enhances the tranquility and premium feel of the artistic atmosphere, guiding the audience to focus on exhibits and spatial experience.
3. Slim lamp body + concealed installation do not block exhibits or damage spatial integrity, making light and shadow echo with art exhibits and architectural structures to improve the aesthetic recognition of the venue.

Mounting Methods

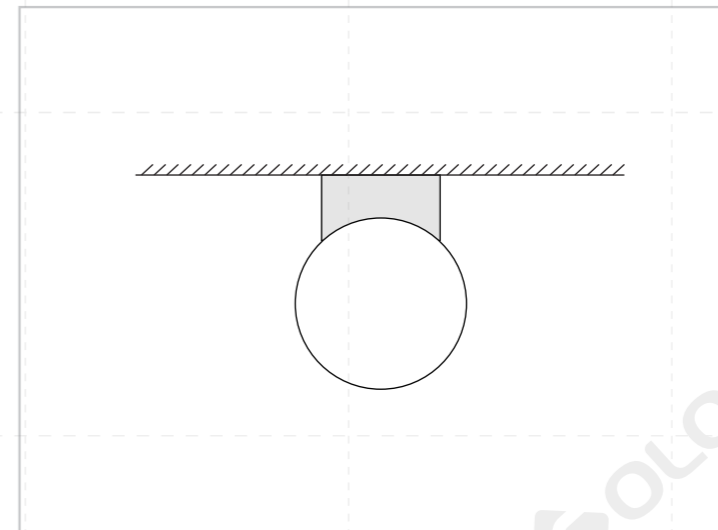

Bending Profile



Splicing Components



Ceiling-mounted Installation Kit



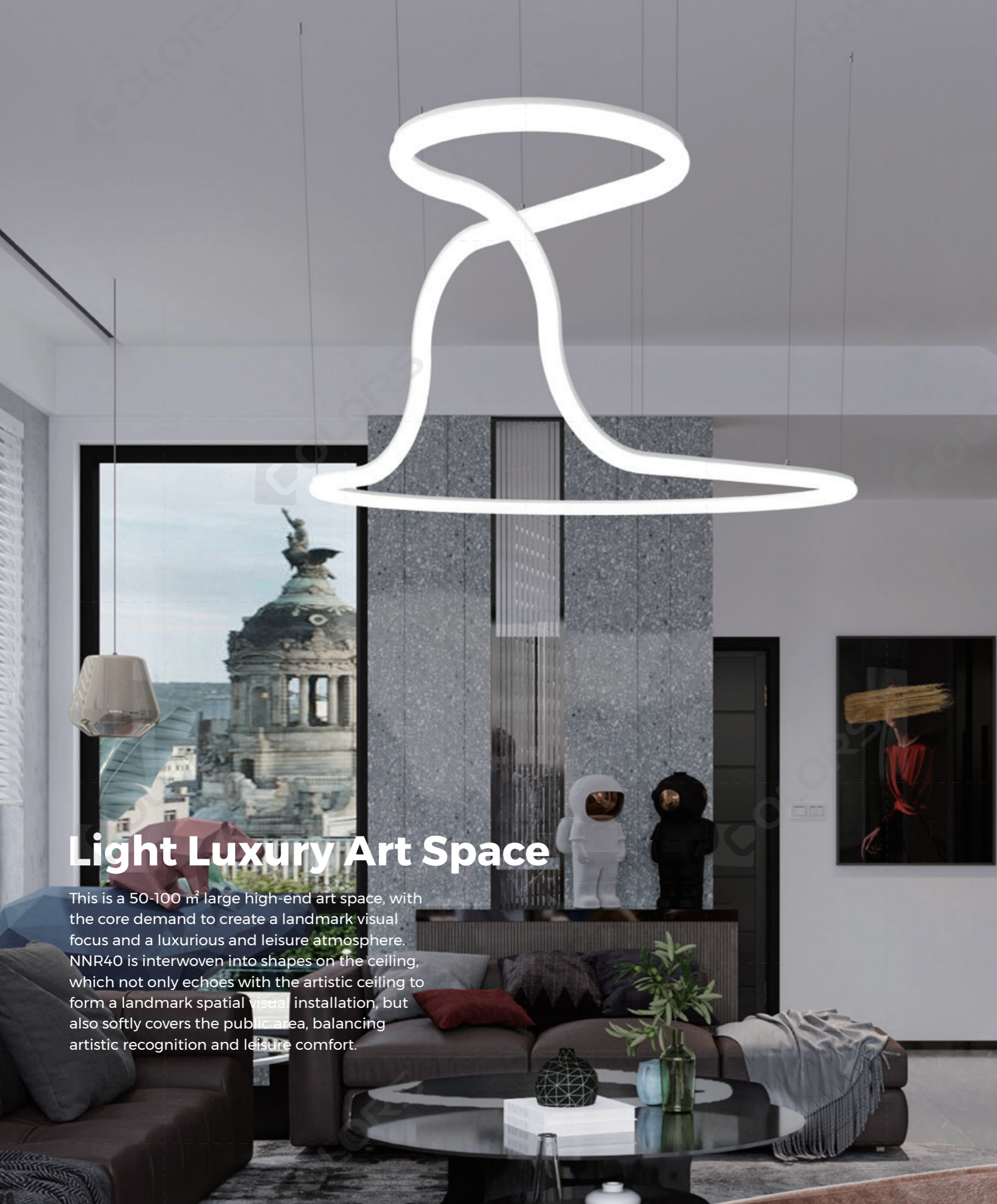

Light Luxury Art Space

This is a 50-100 m² large high-end art space, with the core demand to create a landmark visual focus and a luxurious and leisure atmosphere. NNR40 is interwoven into shapes on the ceiling, which not only echoes with the artistic ceiling to form a landmark spatial visual installation, but also softly covers the public area, balancing artistic recognition and leisure comfort.

Recommended Models



NNR40

Recommended Reasons

1. Glare-free illumination and 3D shaping capability create immersive light and shadow installations that become the visual focus of the space, aligning with the avant-garde design positioning of art venues.

2. Soft and layered light enhances the tranquility and premium feel of the artistic atmosphere, guiding the audience to focus on exhibits and spatial experience.

3. Slim lamp body + concealed installation do not block exhibits or damage spatial integrity, making light and shadow echo with art exhibits and architectural structures to improve the aesthetic recognition of the venue.

Mounting Methods

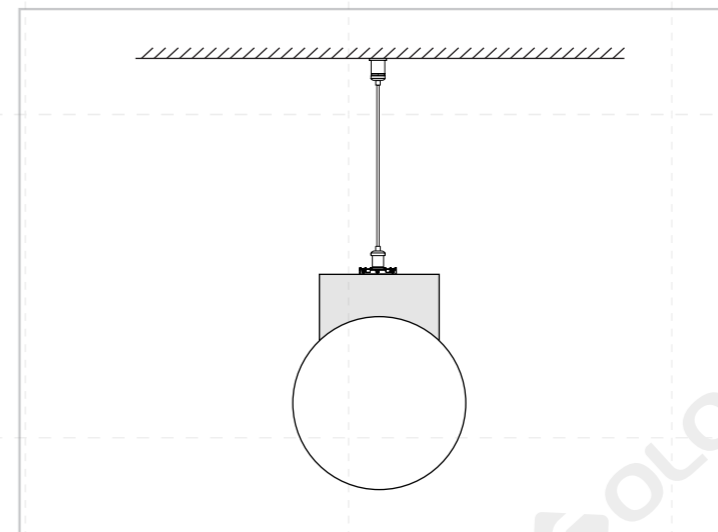

Bending Profile







Splicing Components



Lifting Kit



Size	Model	DC(V)	CCT/Color	Typ.W/m	LM/m*	CRI	LEDs/cut(mm)	Length(m)	EP(IP68)	EP(IP67)	ENP(IP67)	Glue end cap(IP65)	Metal end cap(IP54)	Warranty (years)			
MAGIC 360																	
 φ13mm	NNR13	24	2300 K 2700 K 3000 K 4300 K	8.6	670	> 90	14/25	5	/	/		Top	/	Indoor 5 Outdoor 3			
		48	2300 K 2700 K 3000 K 4300 K	8.6	670	> 90	28/50	10	/	/		Top	/				
 φ18mm	NNR18	24	2300 K 2700 K 3000 K 4000 K	14.4	800	> 90	Free cutting	5	/	/		Top/Side	/	Indoor 5 Outdoor 3			
		24	CCT	14.4	850	> 90	24/31.25	5	/	/		Top/Side	/				
		24	R G B	13	/	/	14/50	5	/	/		Top/Side	/				
		24	G B	10	/	/	14/41.67	5	/	/		Top/Side	/				
		24	2300 K 2700 K 3000 K 3500 K 4000 K	14.4	950	> 90	Free cutting	5	/	/		Top/Side	/				
		24	CCT	14.4	950	> 90	24/31.25	5	/	/		Top/Side	/				
 φ25mm	NNR25	24	G B	10	/	/	14/41.67	5	/	/		Top/Side	/	Indoor 5 Outdoor 3			
		24	R G B	14.4	/	/	14/50	5	/	/		Top/Side	/				
		24	R G B	17.2	570	> 90	24/62.5	5	/	/		Top/Side	/				
		12	S P I	21.6	/	/	Free cutting	5	/	/		Top/Side	/				
		48	2300 K 2700 K 3000 K 4000 K	12.5	1060	> 90	28/83.33	20	/	/		Top/Side	/				
		48	R G B	17.2	540	> 90	48/125	10	/	/		Top/Side	/				
		 φ40mm	NNR40	24	2300 K 2700 K 3000 K 4000 K	15(LP) 18(HP)	910(LP) 2050(HP)	> 90	14/41.67(LP) 16/50(HP)	5	/	/			Top/Side	/	Indoor 5 Outdoor 3



Tel: +86-755-2923-1888

E-mail: colors@colorsled.com

Web: www.colorsled.com

Add: 17F, Block B, Building 2, North of Skyworth

Inno Valley, Shiyan town, Bao'an District, Shenzhen