



Light Rider Series

# LLS-L FREE LIGHT

Linear lighting system

# LLS-L FREE LIGHT

Newly-launched model, super cost-effective luminaire series. Featured in modernist design style, it looks simple and stylish. Delicate technique fosters its premium texture.

## Mainstream Diameter

Light-emitting surface sizes of 30,40, 50, 70 are optional for diverse lighting demands.

## Multiple Light-emitting Methods

Downward lighting, upward and downward lighting are available for choice.

## Handpicked Global-brand Lamp Beads

Adopted high-quality light source -Bridgelux , SDCM≤3, passed LM80, life span>50000 hrs

## High Luminance, High Light Efficiency

Light efficiency reaches up to 110LM/W; complied to D-level ERP energy efficiency.

## German Imported Pc Diffuser

With matter diffusion technique adopted , it emits uniform and soft light.

## Multiple Light-tuning Methods

Built-in slim, high-quality power supply; support no dimming/0-10V/DALI dimming.

## Multiple installation methods

A variety of installation accessories optional, support surface mounting, pendant and embedding for diverse space installation demands.



## BS Model

Pendant, Surface Mounted ,  
Trimless Recessed

## BE Model NEW

Edged Embedding

### Downward Lighting

Downward light-emitting luminaires adopt flood lighting design, featured in uniform light emission. Flood lighting design is an ideal option for providing efficient lighting in public areas.

#### BS3360 / BS5470 / BS7977

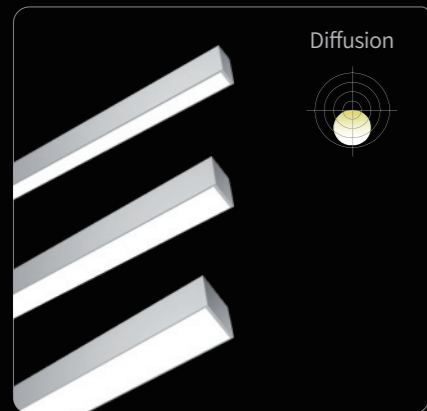

#### BE5535 / BE6935 / BE9435

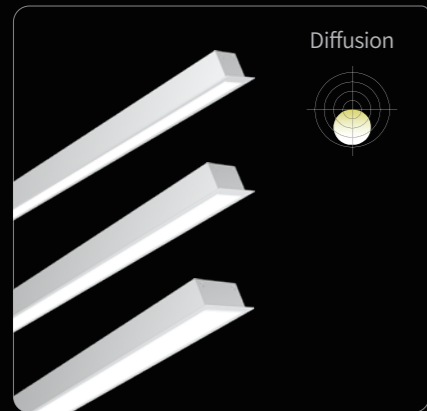

## BH Model

Pendant

### Upward and downward lighting

Upward and downward light-emitting luminaires can provide premium indirect lighting. Abundant downward light will provide excellent basic lighting; large upward light-emitting surface can brighten up ceiling to get more transparent and less depressing space.

#### BH3360

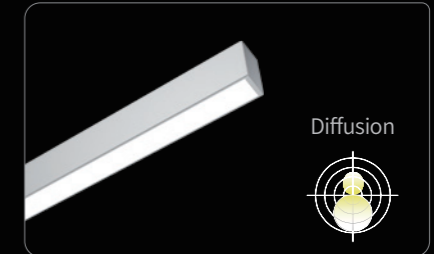

#### BH5470

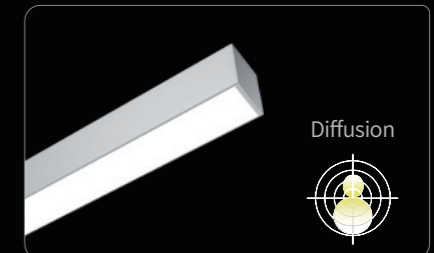

#### BH7977

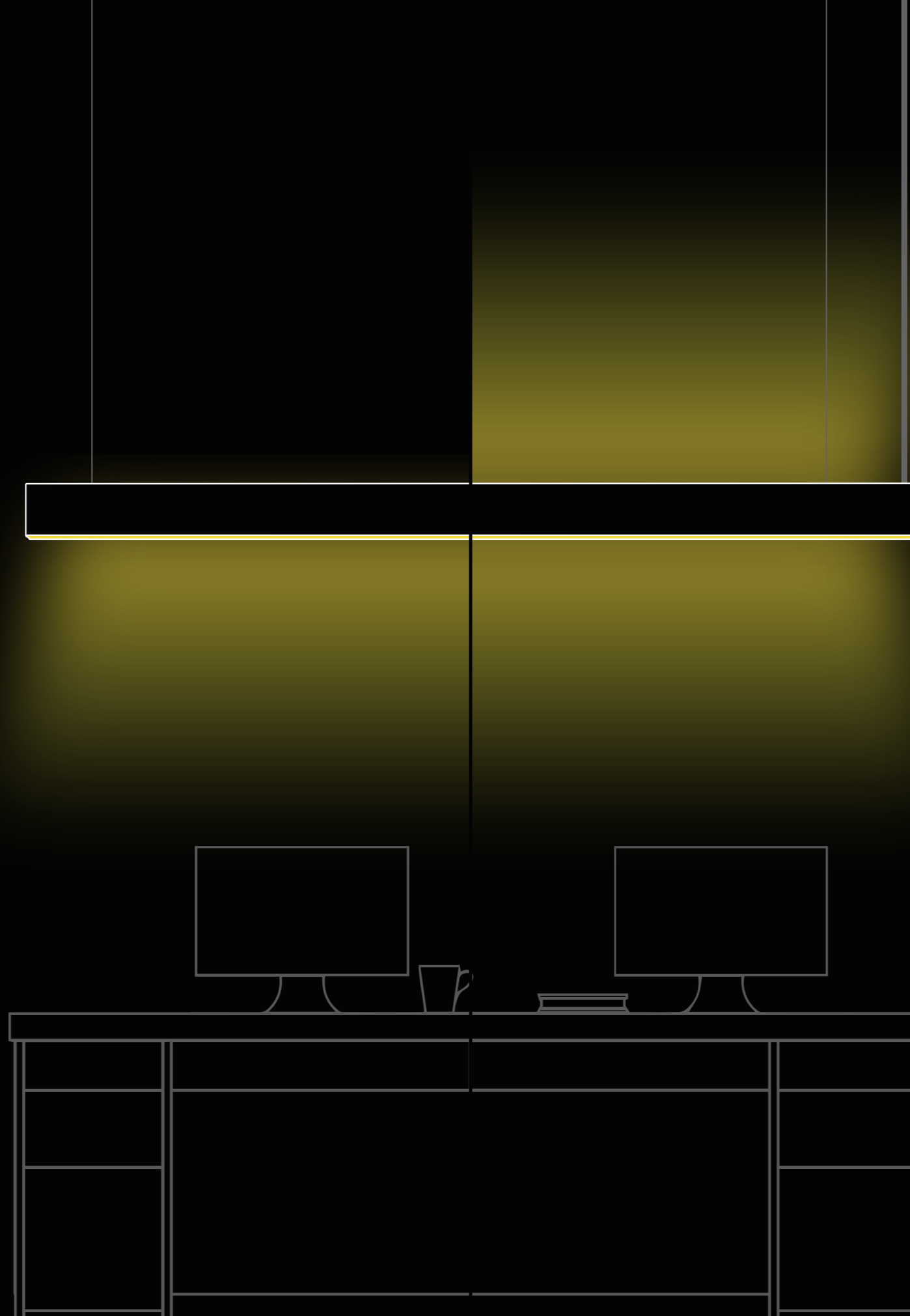
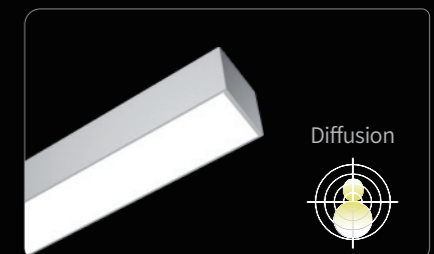

# Installation And Accessory Display

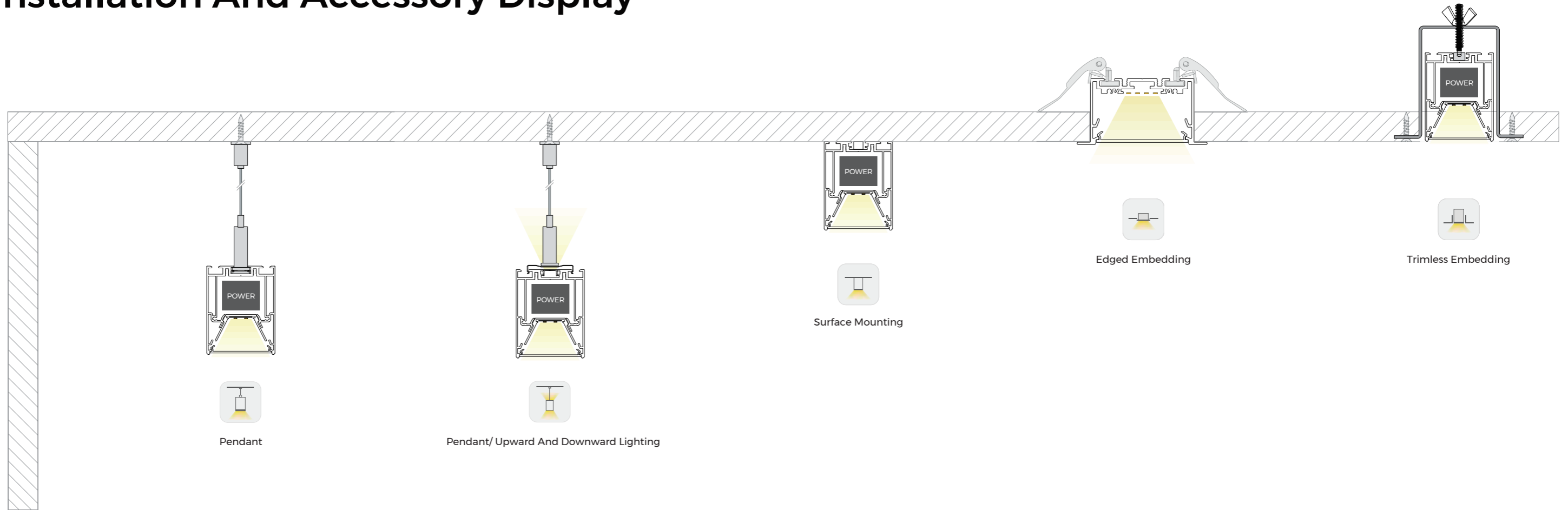

## Size Of Light-emitting Surface

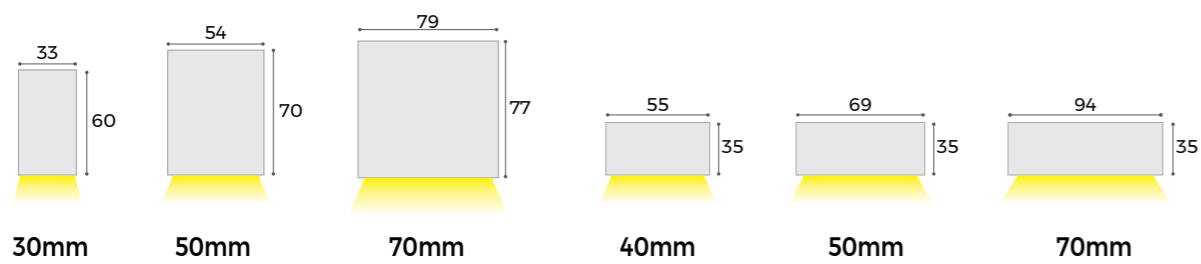

## Optional Lengths

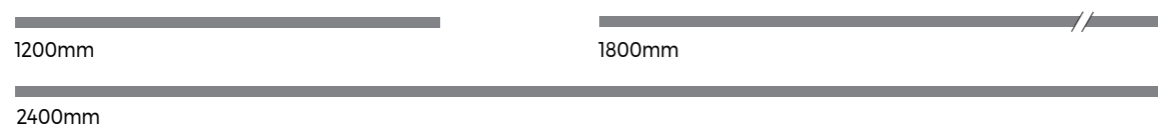

## Lighting method display

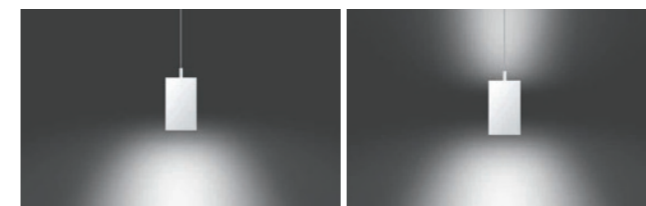

## Directly-connected accessories

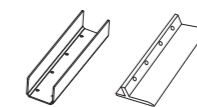

## Whole luminaire splicing bars

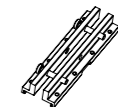

## Installation accessories

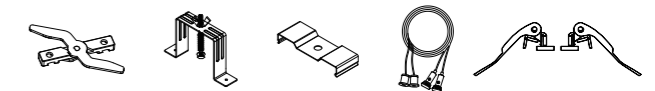

## Light source

2700 K
3000 K
3500 K
4000 K
5000 K
6500 K

## supply power

**30W** 200-240VAC   
 **60W** 200-240VAC   
 **100W** 200-240VAC

## surface process



## Ingenious design · Supreme experience

Linear power supply, perfectly built in luminaire, carrier can be easily detached by a screwdriver. Ultra-long flexible diffuser helps emit uniform and soft light with transmittance > 85%. The whole luminaire can be externally spliced at ease. Innovative anti-leakage design, convenient diffuser detachment and luminaire maintenance. Five kinds of finished accessories, no need to cut. Integrated wiring, more aesthetic outlook. Three colors optional and customizable.

- 1** Built-in linear power supply
- 2** Easy to detach
- 3** Press it to open
- 4** All-wrapped light leak-proof end cap
- 5** Whole luminaire splicing bars
- 6** Seamless splicing
- 7** Standard corner accessories
- 8** Integrated wiring
- 9** Three Colors Optional

# 1

## Built-in Linear Power Supply

- Outfitted with super-slim constant-voltage power supply
- Three powers optional; perfectly built in luminaires.



# 2

## Easy to detach

- Easily detached by a single pry-up of screwdriver.
- Reduce high-altitude operations, convenient for future maintenance.

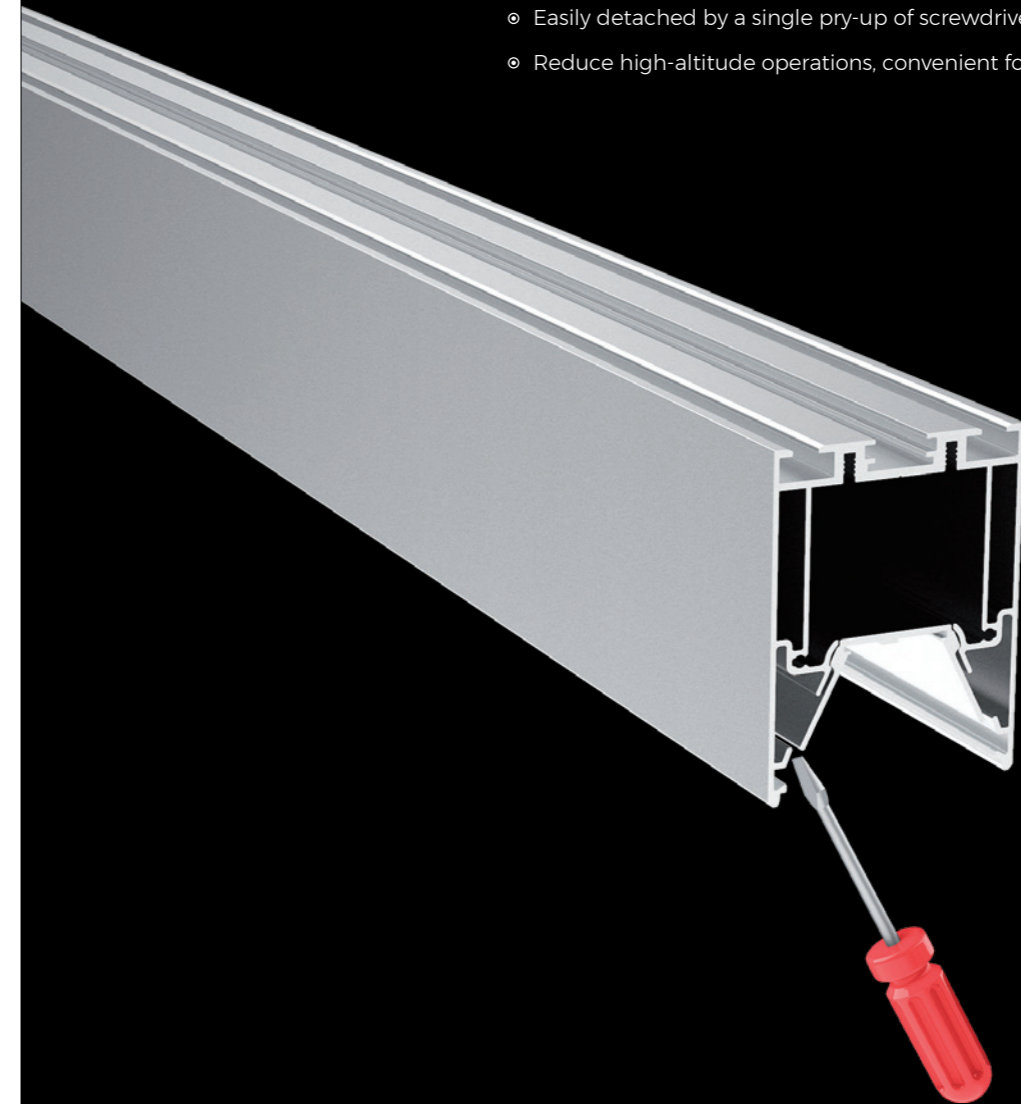

←  
Pry to detach

# 3

## Press it to open

- ◉ Matte diffusion process adopted; featured in uniform and soft lighting
- ◉ Light transmittance >85%



◉ 50m per roll of flexible diffuser, achieves ultra-long application without light leakage.

# 4

## All-wrapped light leak-proof end cap

- ◉ Innovative light leak-proof design adopted;
- ◉ Detachable diffuser assures of easier maintenance;
- ◉ End cap has a shading edge to prevent light leakage from the diffuser;
- ◉ Innovative snap-on end cap adopted for easy operation.

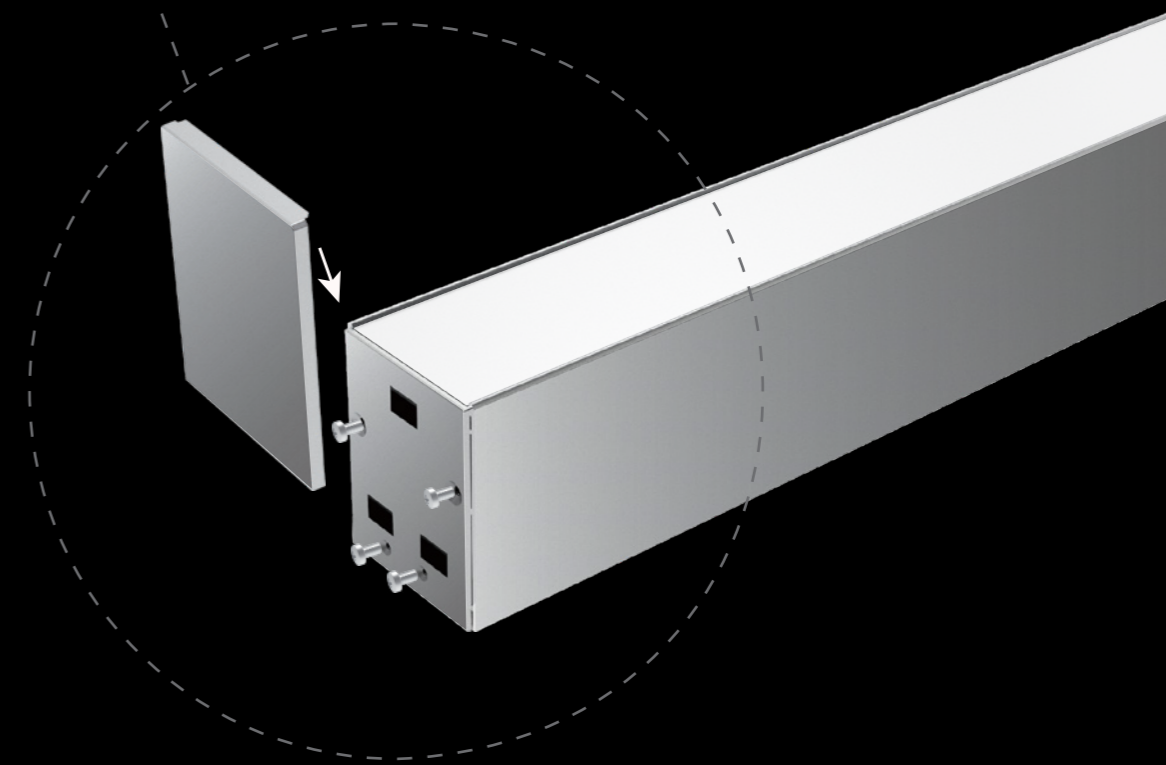
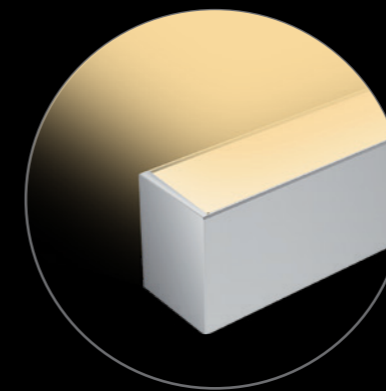

NEW

# 5

## Whole luminaire splicing bars

- ◉ Splice without needs for detaching end caps
- ◉ Efficient and convenient



# 6

## Seamless splicing

- ◉ Standard accessories, portable splicing
- ◉ Tightly connected, no light leakage

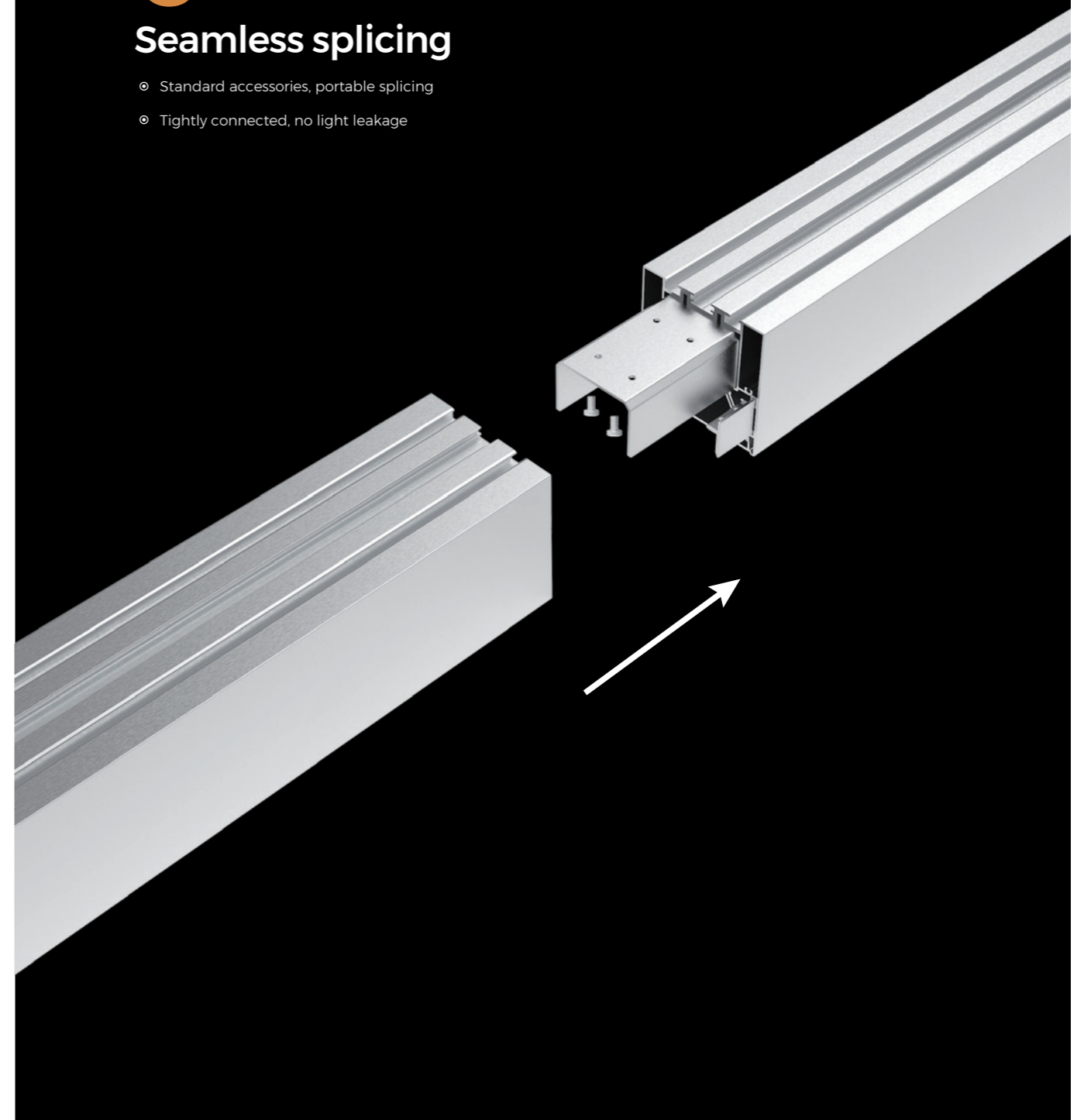



# 7

## Standard corner accessories

- ⦿ Five accessories provided, no cutting required;
- ⦿ Seamless splicing, aesthetic design.

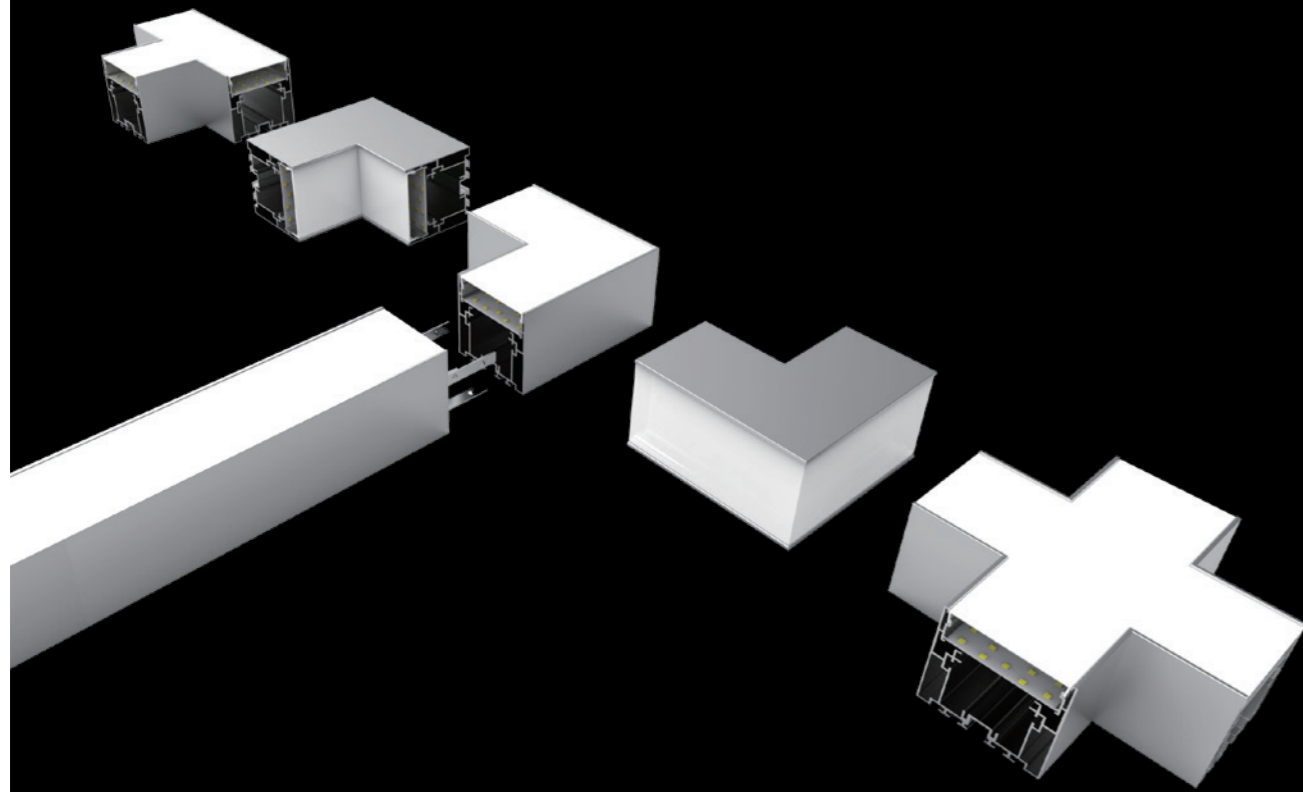

# 8 Integrated wiring

Conducive to aesthetic appearance

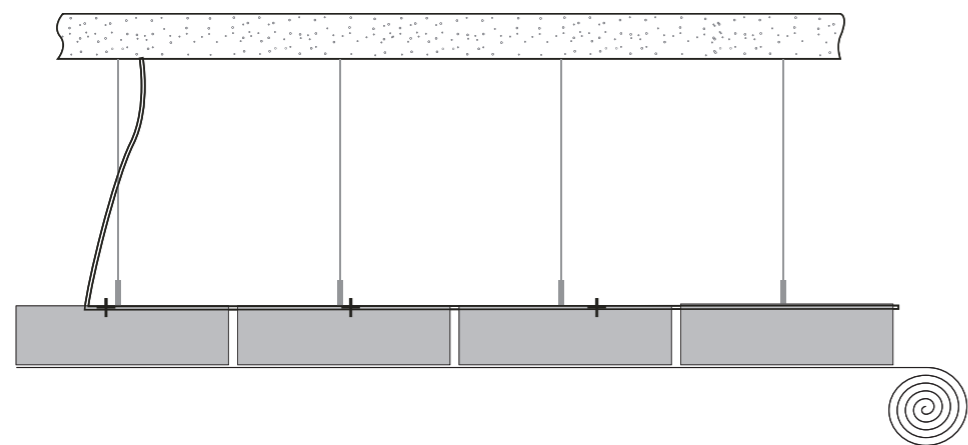

Quick connector adopted

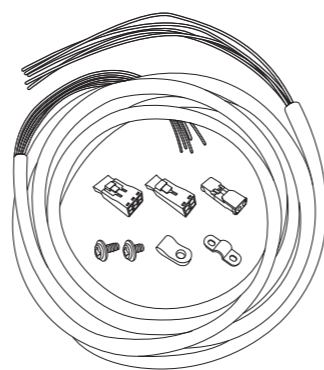

for easy connection.

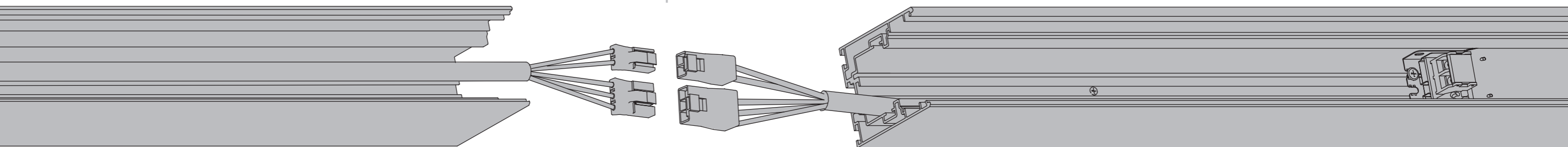
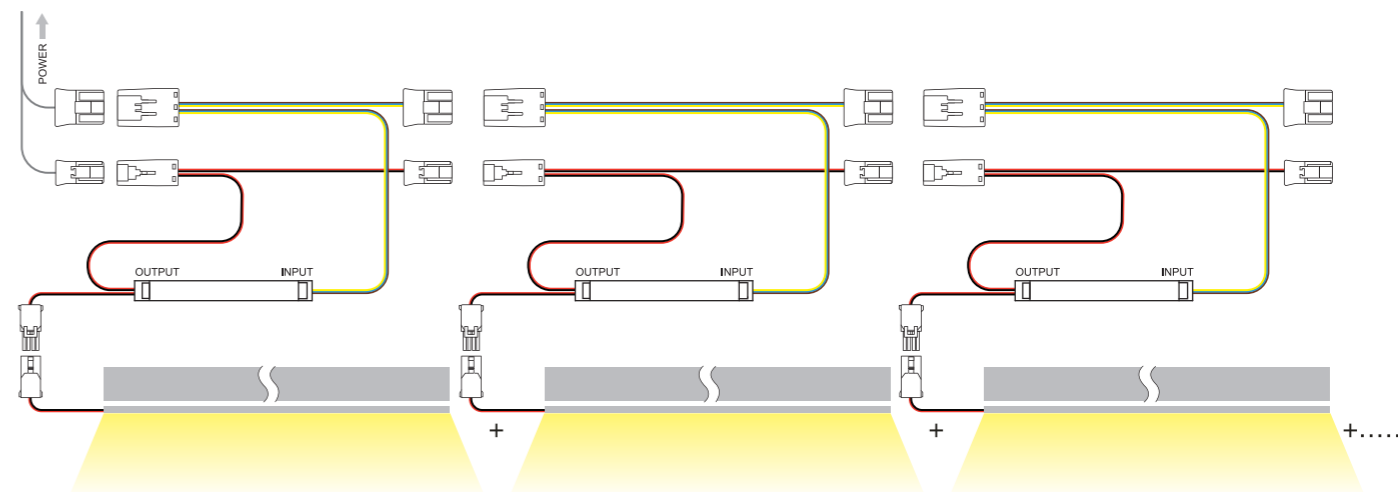

# 9 Three Colors Optional

Black, white and silver optional, Supports color customization

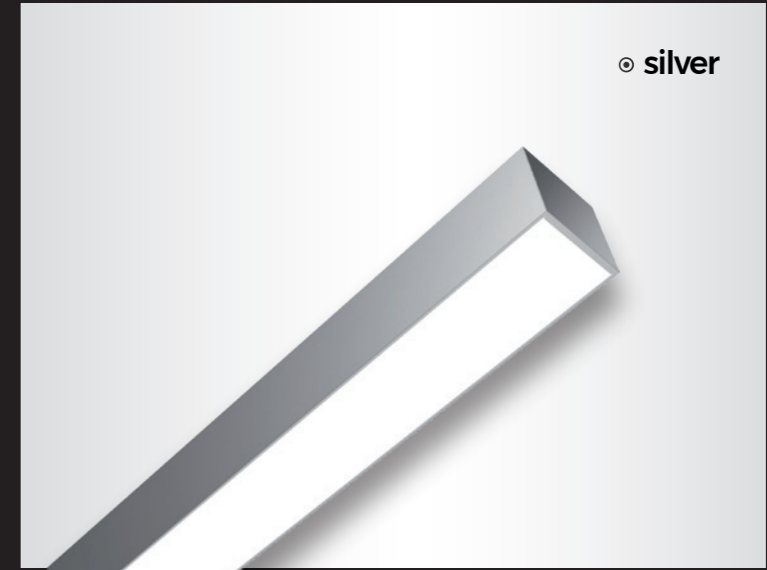
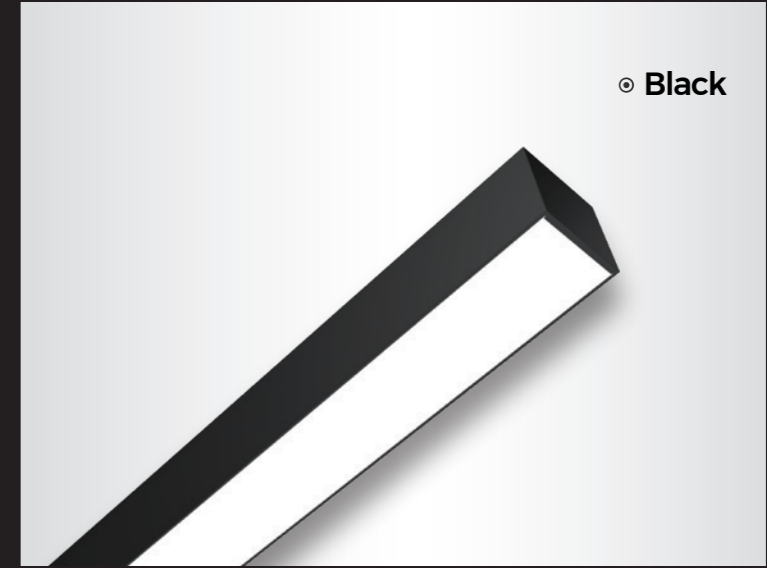



## Superb performance Superb quality

Support 3 dimming modes and dial switch for three-gears CCT adjustment, featured hand-picked qualified lamp beads, assuring you of high quality. Built in with emergency power for 3h lighting during a power outage. Available in multiple installation accessories, can satisfy needs for edged embedded, trimless recessed, pendant and ceiling installation. Support 6 splicing methods for creative styling at will.

- 1** Three light-tuning modes
- 2** Dial switch for CCT adjustment
- 3** Built-in emergency power
- 4** Multiple CCT Optional
- 5** Flexible Application, Playing Around Light
- 6** Arbitrary splicing

# 1

## Three Light-tuning Modes

- ◉ Outfitted with slim and high-quality power supply;
- ◉ Perfectly built in linear luminaire, achieves free light tuning.



**NO  
DIMMING**

Supports no dimming

**1-10V**

+ 1-10V Dimming



DALI dimming



100%

75%

50%

25%



## 2 Dial switch for CCT adjustment

⦿ Outfitted with dial switch for flexible three-gears dimming

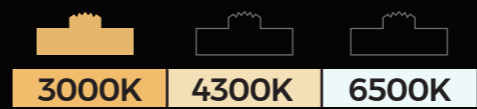
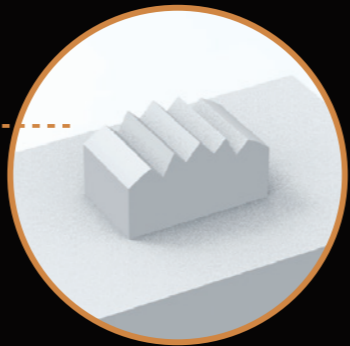

**3000K**

Warm light · Warm atmosphere

**4300K**

Neutral light · Soft and natural

**6500K**

White light · Bright and comfortable



NEW



Built-in emergency power

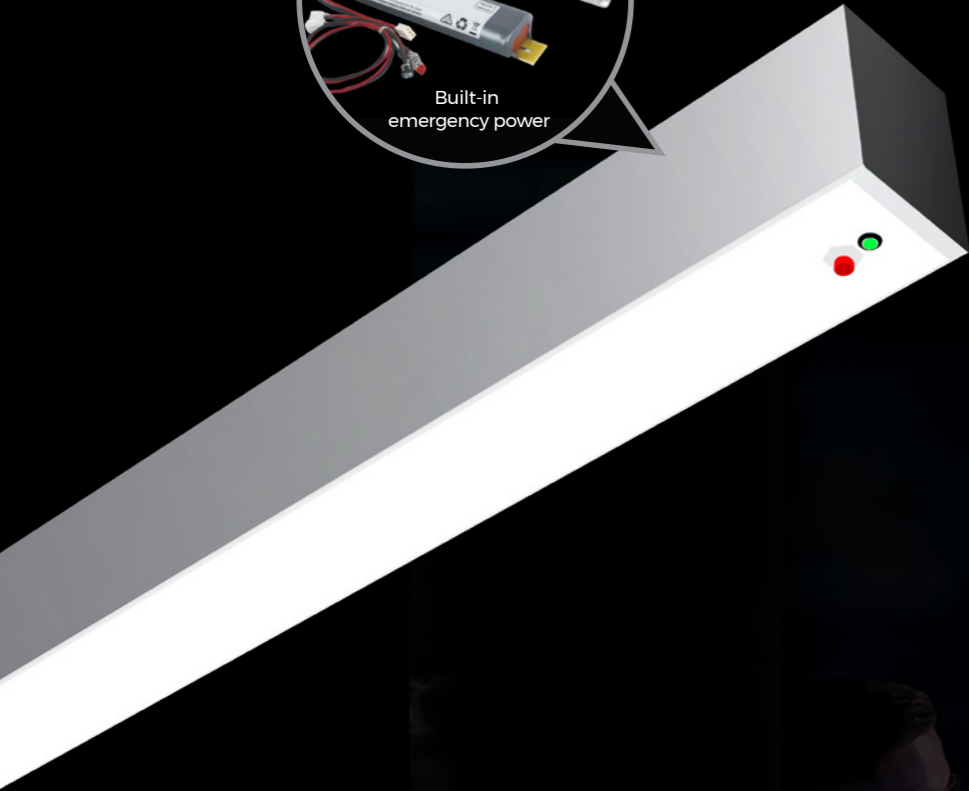

### 3

**Built-in emergency power**  
**Emergency lighting for 3 hours in case of power outage**

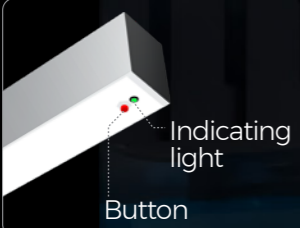

- ◉ When power supply is working, indicating light is off
- ◉ When power supply is charging, indicating light is green
- ◉ Red button, one-click detection



# 4

## Multiple Cct Optional

Supports Cct  
Customization

2700K

3000K

3500K

4000K

5000K

6500K

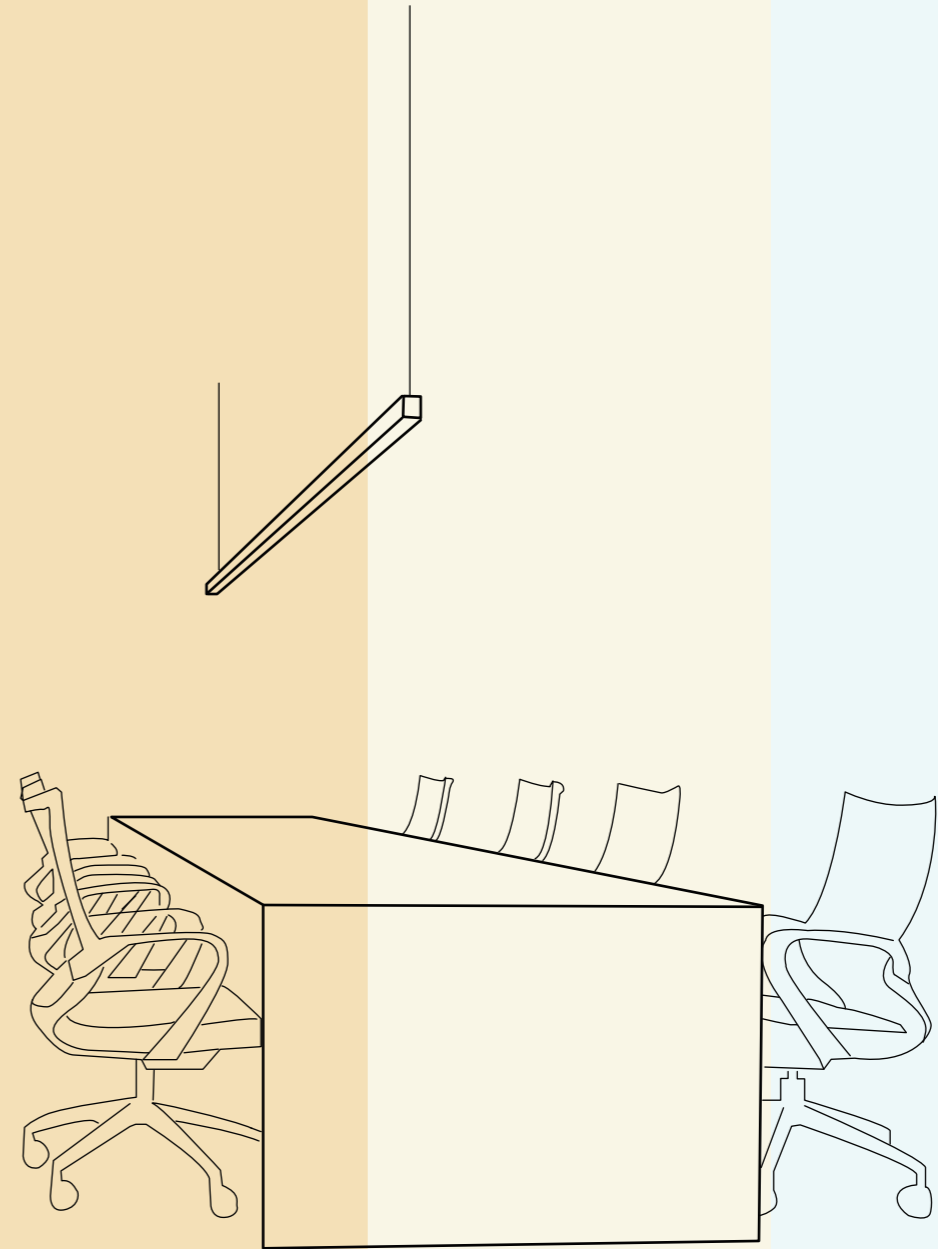



# 5 Meet various installation requirements

Satisfy needs for edged embedded, trimless recessed, pendant and ceiling installation.

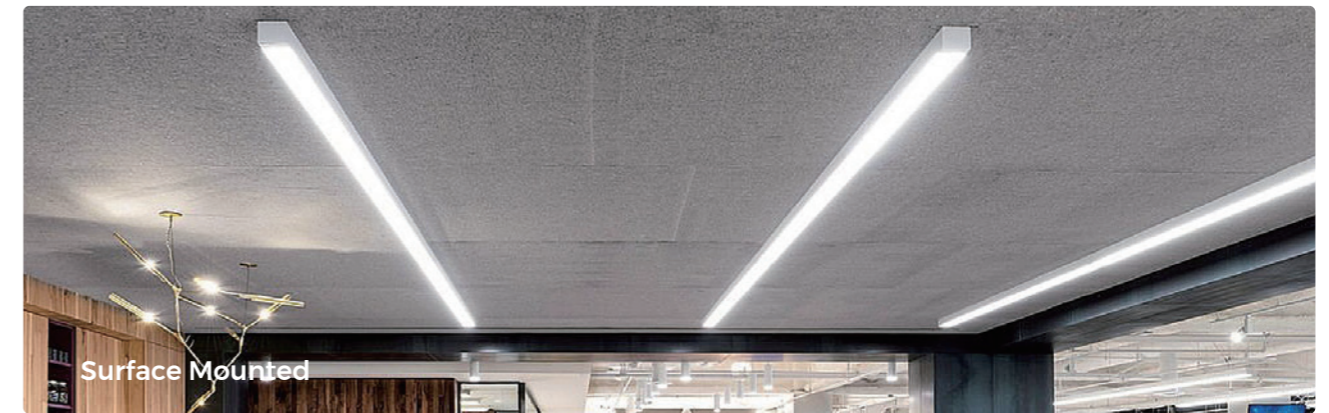
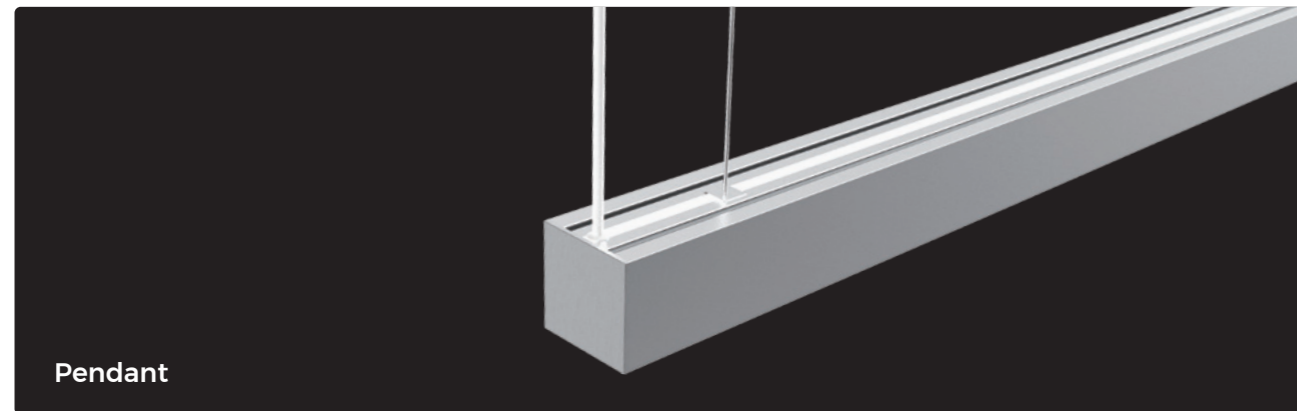
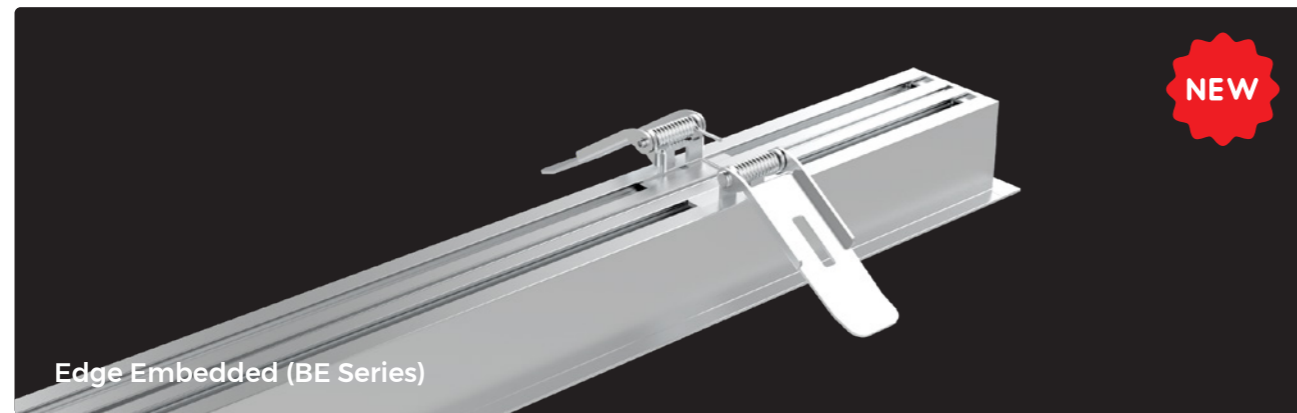
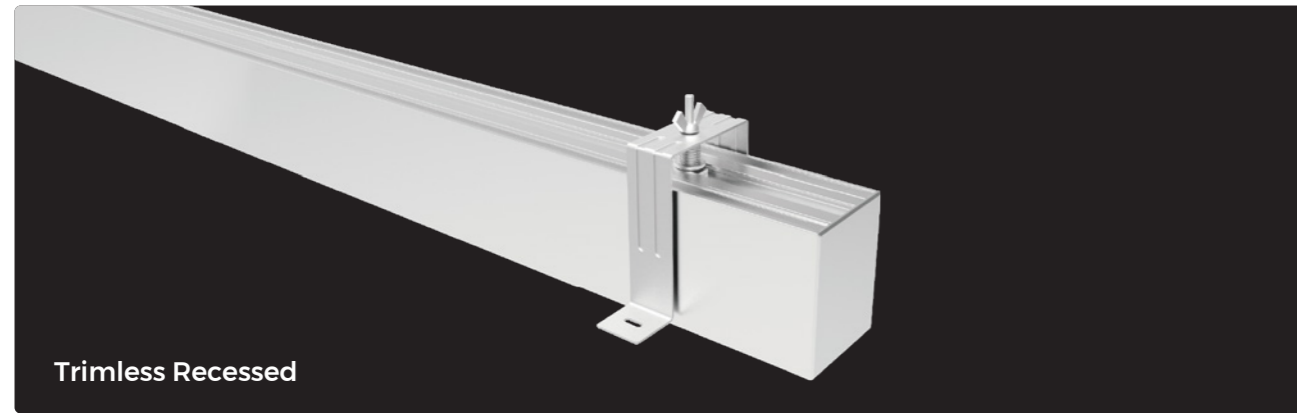
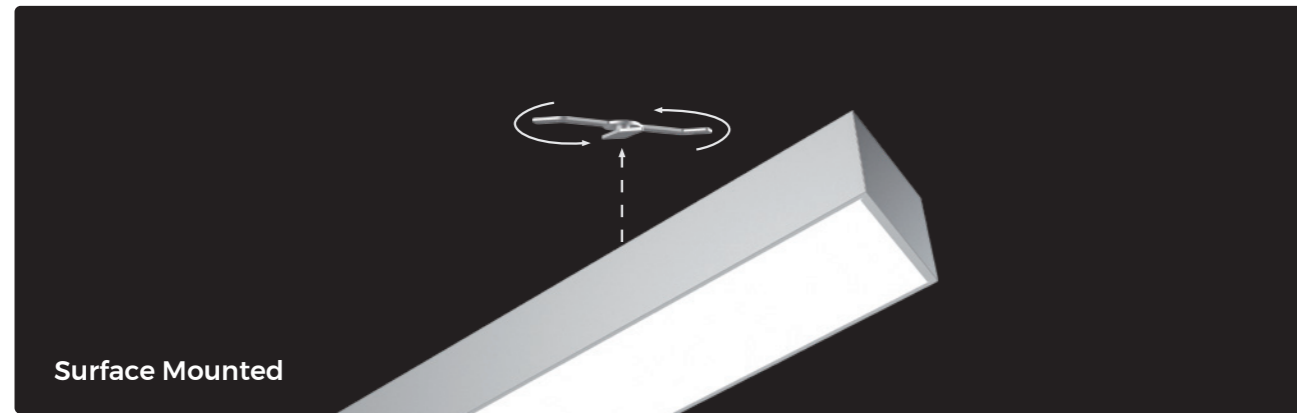

# 6

## Arbitrary Splicing

- Six splicing methods
- Freely forms boundless space styling

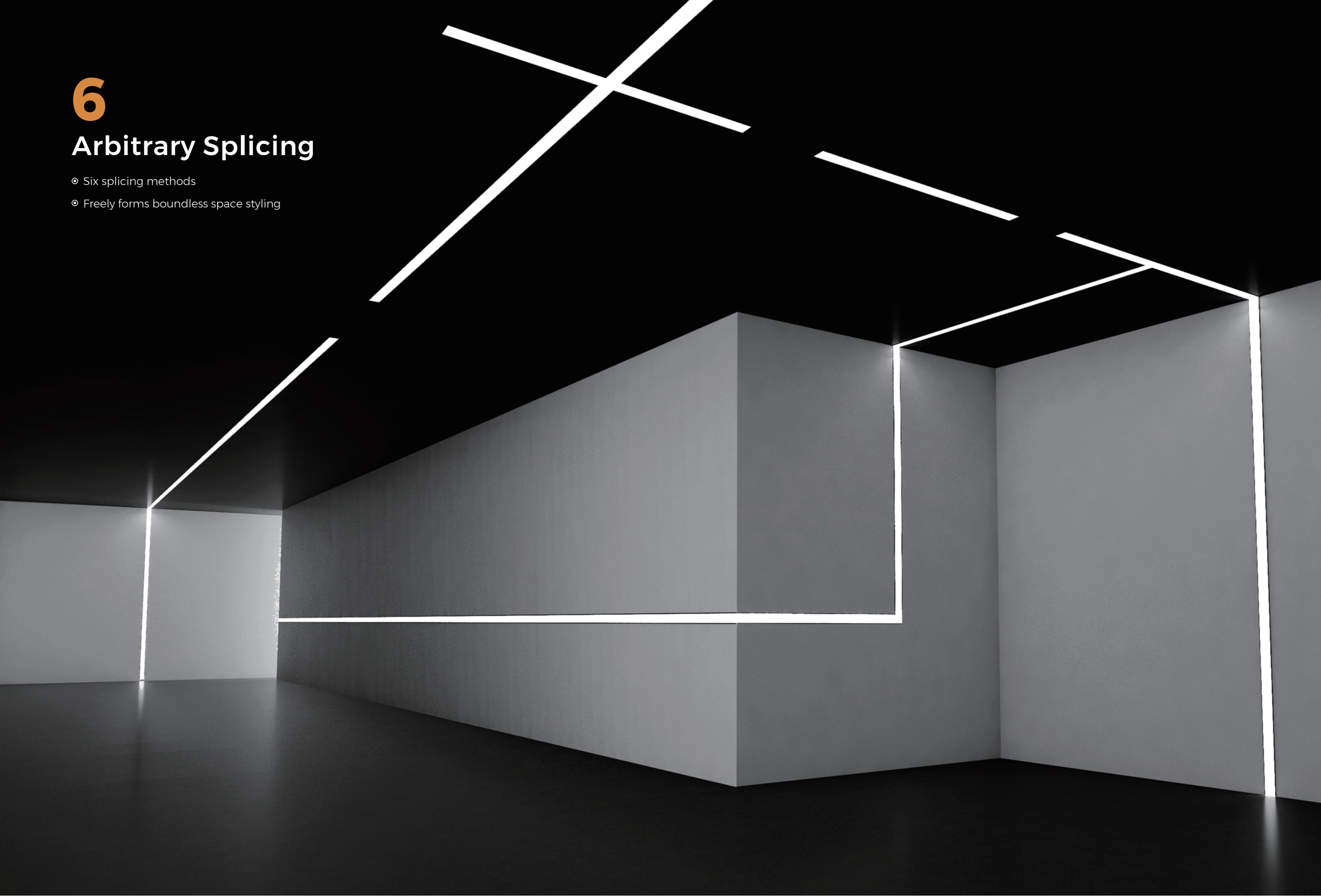

## Practical Application Cases

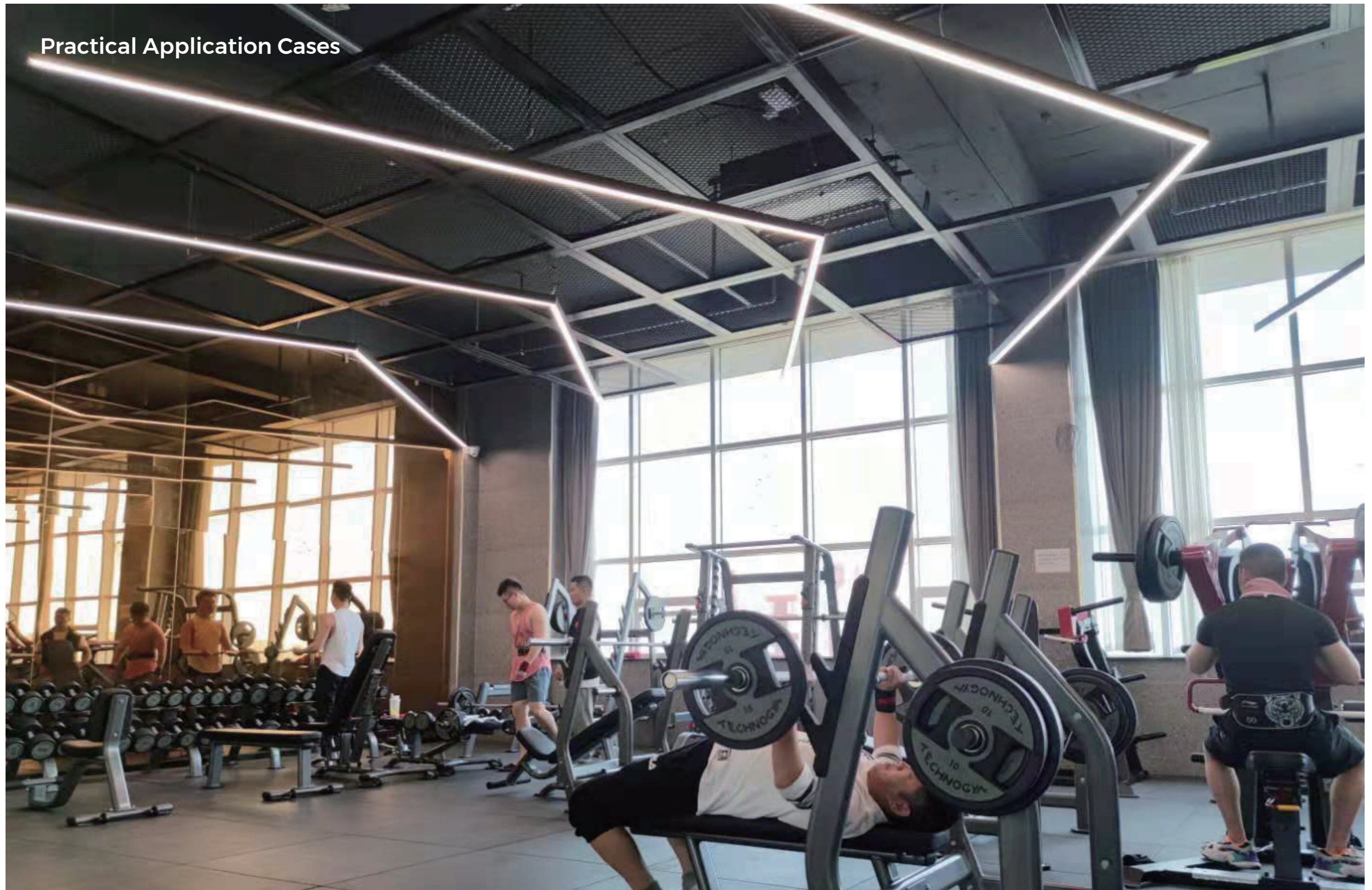

# Practical Application Cases





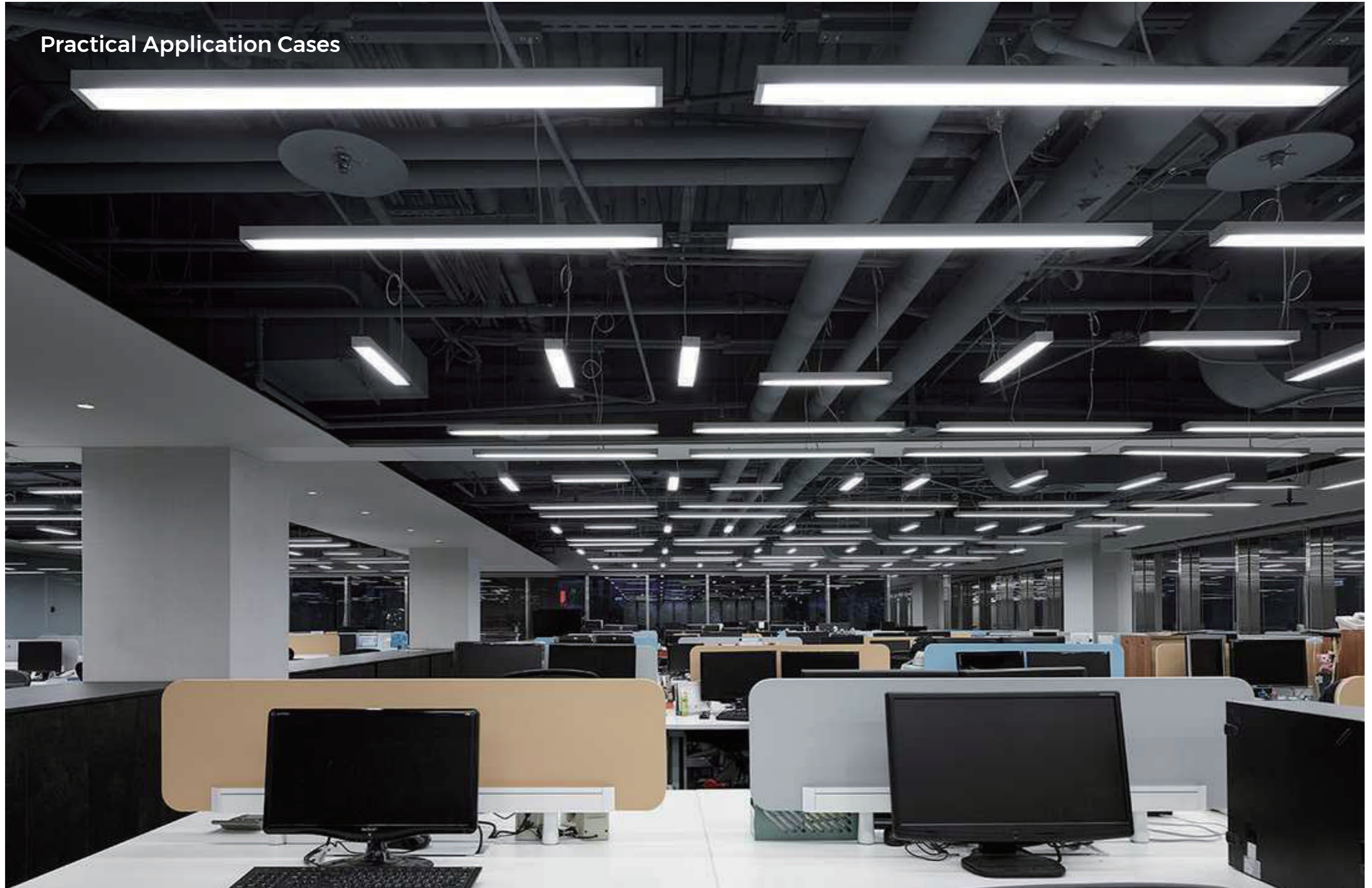







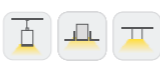

































## Practical Application Cases



# Practical Application Cases



# Product list









Model	Icon	Product Size(Mm)	Installation Method	Exterior Color	Standard Splicing Strip	Stitching Corner	Dedicated Light Source
BS3360		2500X33X60					DL8160-24V-8mm
BS5470		2500X54X70					DL280-24V-18mm
BS7977		2500X79X77					DL280-24V-30mm
BH3360		2500X33X60					Down Light: DL8160-24V-8mm Up Light: DL880-24V-8mm
BH5470		2500X54X70					Down Light: DL280-24V-18mm Up Light: DL160-24V-8mm
BH7977		2500X79X77					Down Light: DL280-24V-30mm Up Light: DL160-24V-8mm
BE5535 <span style="color:red">NEW</span>		2500X55X35					DL8160-24V-8mm
BE6935 <span style="color:red">NEW</span>		2500X69X35					DL280-24V-18mm
BE9435 <span style="color:red">NEW</span>		2500X94X35					DL280-24V-30mm

# Light Source

Model	Drawing	LEDs/m	LEDs/cut	Way out	Input voltage	Maximum Power	Typical power	Luminous flux (4000K)	CRI	CCT/Color	size	Packing	Adapted models
Flexible board light strip													
DL880-24V-8mm		80	8/100mm		24	8.2	7.5	1190	>80 >90		2500x8x1.5mm	2.5M/Roll	Up Light: BH3360
DL8160-24V-8mm		160	8/50mm		24	16.5	15	2015	>80 >90		2500x8x1.5mm	2.5M/Roll	Down light: BS3360/BH3360/BE5535 Up Light: BH5470/BH7977
DL8280-24V-18mm		280	14/50mm		24	27.5	25	3400	>80 >90		2500x18x1.5mm	2.5M/Roll	Down light: BS5470/BH5470/BE6935
DL8280-24V-30mm		280	14/50mm		24	33	30	4080	>80 >90		2500x30x1.5mm	2.5M/Roll	Down light: BS7977/BH7977/BE9435

# Power Supply for LLS-L



Model	Drawing	Size L*W*H(mm)	Input Voltage	Input Current	Output Voltage	Output Current	Output Power	Power Factor	Power Efficiency	Certification
<b>DALI dimming driver</b>										
LV30W24 DALI		230×30×21mm	200-240VAC	0.18A Max	DC24V	1.25A Max	30W	0.92	83%	CE, ENEC
BK-DGV060-24V0D		285×30×21mm	200-240VAC	0.35A Max	DC24V	2.5A Max	60W	0.95	90%	CE, ENEC
BK-DGV100-24V0D		355×30×21mm	200-240VAC	0.7A Max	DC24V	4A Max	100W	0.95	91%	CE, ENEC
<b>1-10V dimming driver</b>										
LV30W24 1-10		230*30*21mm	200-240VAC	0.18A Max	DC24V	1.25A Max	30W	0.92	83%	CE, ENEC
BK-MGV060-24V0M		285*30*21mm	200-240VAC	0.35A Max	DC24V	2.5A Max	60W	0.95	89%	CE, ENEC
BK-MGV100-24V0M		355*30*21mm	200-240VAC	0.7A Max	DC24V	4A Max	100W	0.95	91%	CE, ENEC
<b>No dimming driver</b>										
BN-V24-030P-VI		261*30*17mm	220-240VAC	0.24A Max	DC24V	1.25A Max	30W	0.95	85%	CE
BN-V24-060P-VI		329*30*17mm	220-240VAC	0.46A Max	DC24V	2.5A Max	60W	0.95	89%	CE
BN-V24-100P-VI		365*30*18mm	220-240VAC	0.78A Max	DC24V	4.17A Max	100W	0.95	91%	CE



# BS3360\_Component

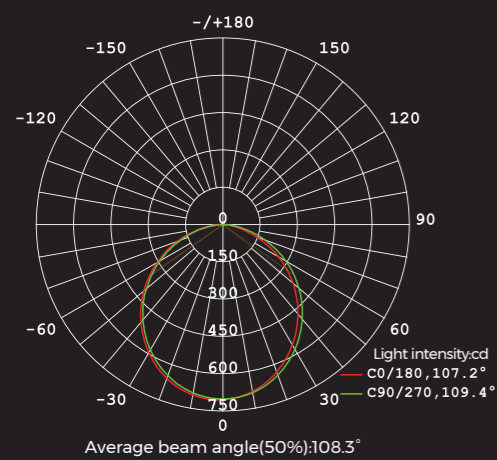
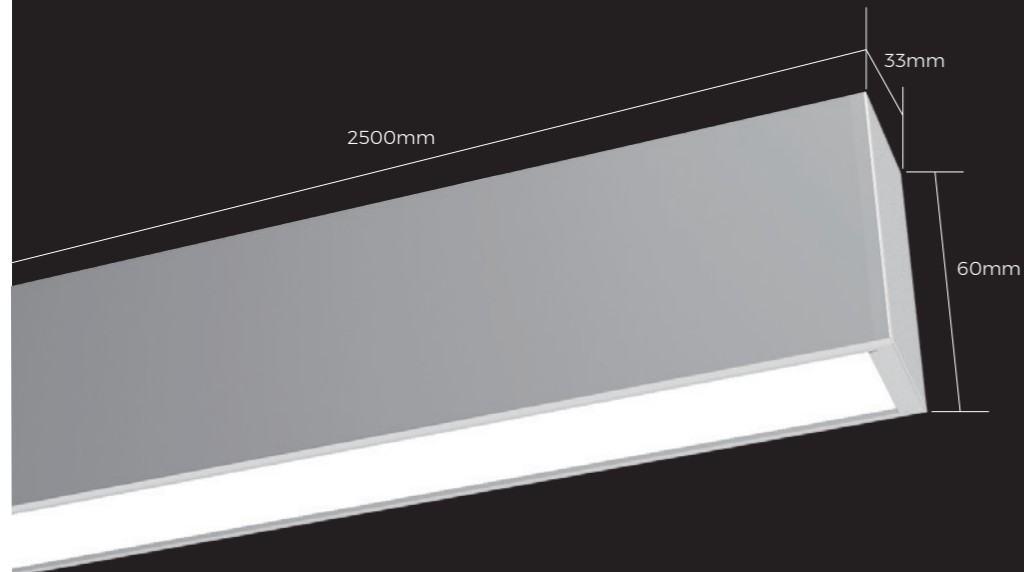

high	Eavg, Emax	Luminous flux angle: 107.23°	diameter
1m	226.8, 704.2lx		271.42cm
2m	56.69, 176.0lx		542.85cm
3m	25.20, 78.24lx		814.27cm
4m	14.17, 44.01lx		1085.69cm
5m	9.071, 28.17lx		1357.12cm
6m	6.299, 19.56lx		1628.54cm
7m	4.628, 14.37lx		1899.96cm
8m	3.543, 11.00lx		2171.38cm
9m	2.800, 8.693lx		2442.81cm
10m	2.268, 7.042lx		2714.23cm

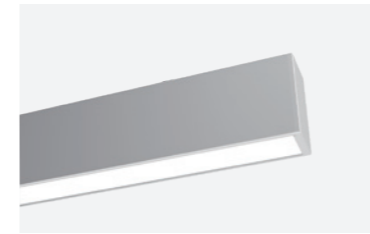

## Profile

Material: aluminum 6063

Process: Anodizing/ Spraying

Color: Silver/ Black/ White

## Installation Accessories

Pendant Component (with ceiling box)	PY-D 2m/4m	
Pendant Component (without ceiling box)	PN-D 2m/4m	
Ceiling screw	CL-01 M3.5X40mm	
Boom	PG-I	
Ceiling clips	CP-42	
Integrated Wiring Accessories	Dimming solution model CM-03 CM-06 Non-dimming solution model CM-04 CM-05	

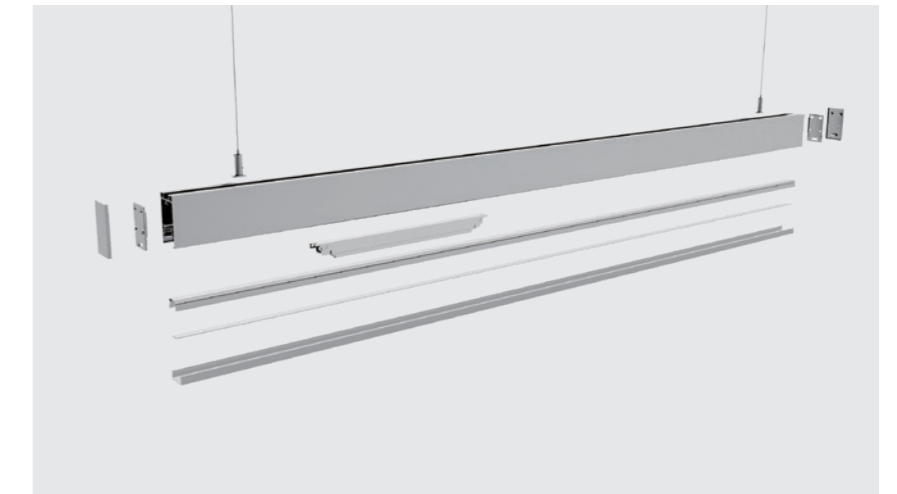

## Corner accessories

L-shaped Corner	L90-BS3360 150X150X60mm	
L-shaped Corner (Inward)	L90N-BS3360 150X150X33mm	
L-shaped Corner (Outward)	L90W-BS3360 150X150X33mm	
T-shaped corner	T90-BS3360 300X166.5X60mm	
X-shaped corner	X90-BS3360 300X300X60mm	

\* None of the five corners contains light sources.

## Connection Accessories

Extender	EX-38 150X30X34.5mm		Whole luminaire splicing bars	EX-41 110X115X11.7mm	
----------	------------------------	--	-------------------------------	-------------------------	--

## Power Accessories

Model	Diameter	Output Voltage	Output Power	Diagram
BN-V24-060P-V1	261X30X17mm	24VDC	60W	

① Parts in profile components can be purchased separately.

② Being outfitted with or without light source in corners is optional.

③ The test result of product with luminous flux of 4000K.

④ You can select a power supply with lower power as per practical light effects demands.

# BS5470\_Component

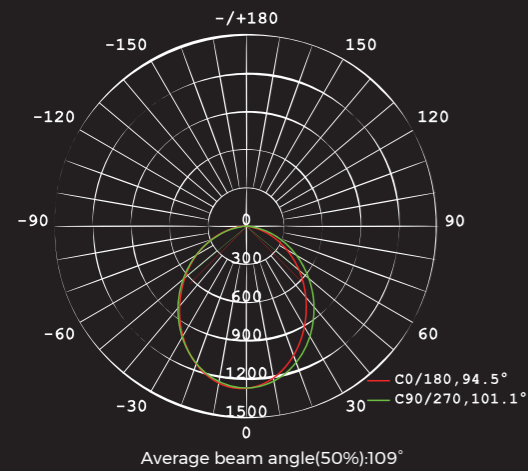
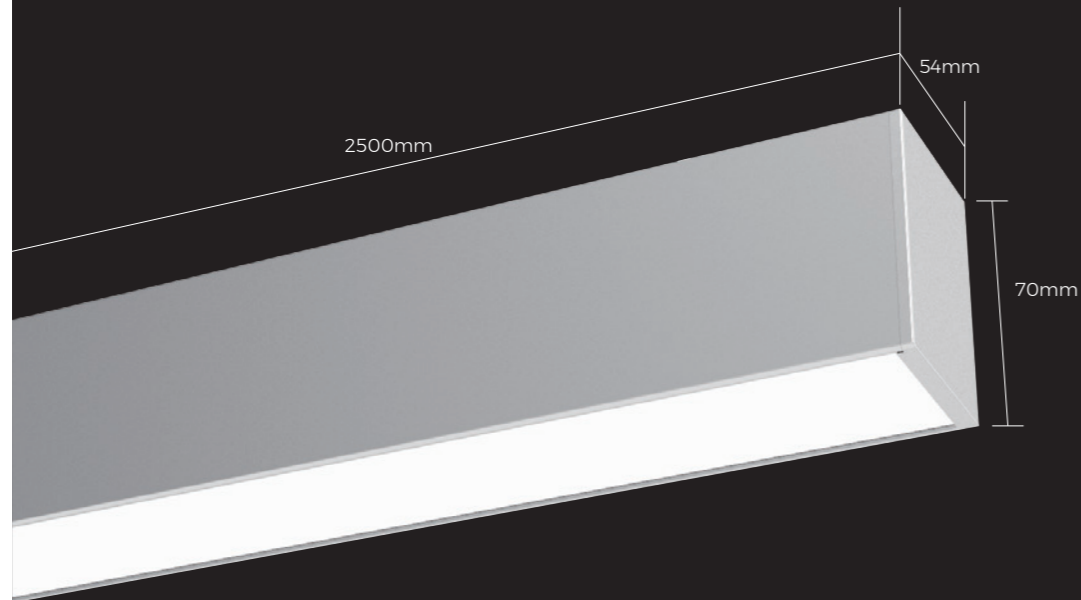

high	E <sub>avg</sub> , E <sub>max</sub>	Luminous flux angle: 94.54°	diameter
1m	498.9, 1269lx		216.52cm
2m	124.7, 317.1lx		433.04cm
3m	55.43, 141.0lx		649.56cm
4m	31.18, 79.29lx		866.08cm
5m	19.95, 50.74lx		1082.60cm
6m	13.86, 35.24lx		1299.12cm
7m	10.18, 25.89lx		1515.63cm
8m	7.795, 19.82lx		1732.15cm
9m	6.159, 15.66lx		1948.67cm
10m	4.989, 12.69lx		2165.19cm



Profile

Material: aluminum 6063

Process: Anodizing/ Spraying

Color: Silver/ Black/ White

## Installation Accessories

Pendant Component (with ceiling box)	PY-D 2m/4m	
Pendant Component (without ceiling box)	PN-D 2m/4m	
Boundless embedded accessories	RE-03 110X25X82mm	
Ceiling accessories	CL-06 90.5X54X5.9mm	
Boom	PG-I	
Integrated Wiring Accessories	Dimming solution model CM-03 CM-06 Non-dimming solution model CM-04 CM-05	

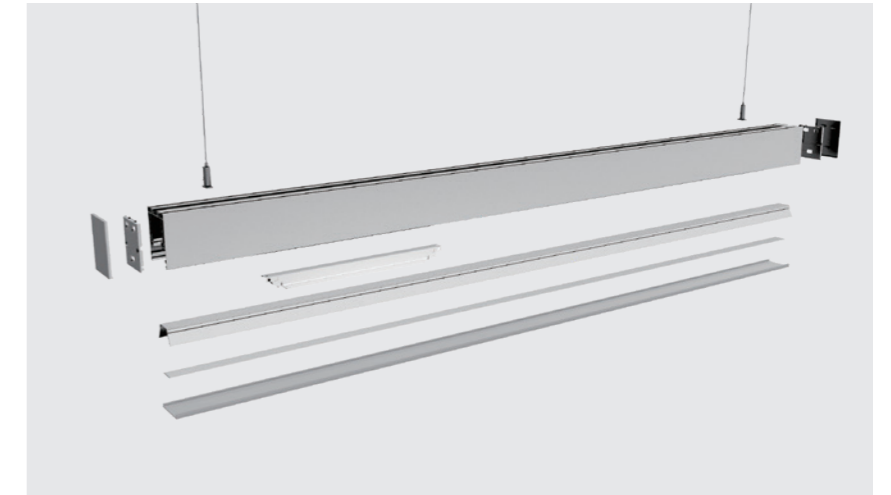

## Corner accessories

L-shaped Corner	L90-BS5470 150X150X70mm	
L-shaped Corner (Inward)	L90N-BS5470 150X150X54mm	
L-shaped Corner (Outward)	L90W-BS5470 150X150X54mm	
T-shaped corner	T90-BS5470 300X177.5X70mm	
X-shaped corner	X90-BS5470 300X300X70mm	

\* None of the five corners contains light sources.

## Connection Accessories

Extender	EX-39 150X37.2X29.8mm		Whole luminaire splicing bars	EX-41 110X15X11.7mm	
----------	--------------------------	--	-------------------------------	------------------------	--

## Power Accessories

Model	Diameter	Output Voltage	Output Power	Diagram
BN-V24-060P-V1	261X30X7mm	24VDC	60W	

① Parts in profile components can be purchased separately.

② Being outfitted with or without light source in corners is optional.

③ The test result of product with luminous flux of 4000K.

④ You can select a power supply with lower power as per practical light effects demands.

# BS7977\_Component

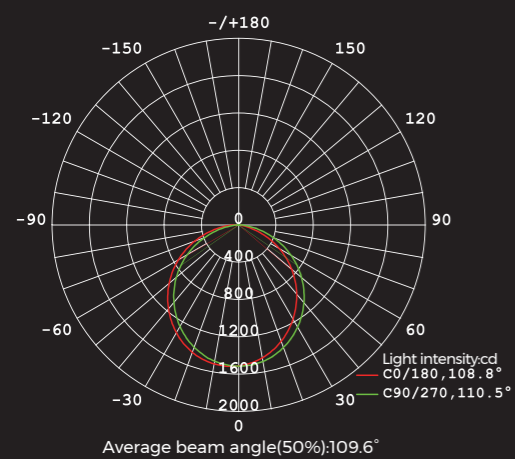
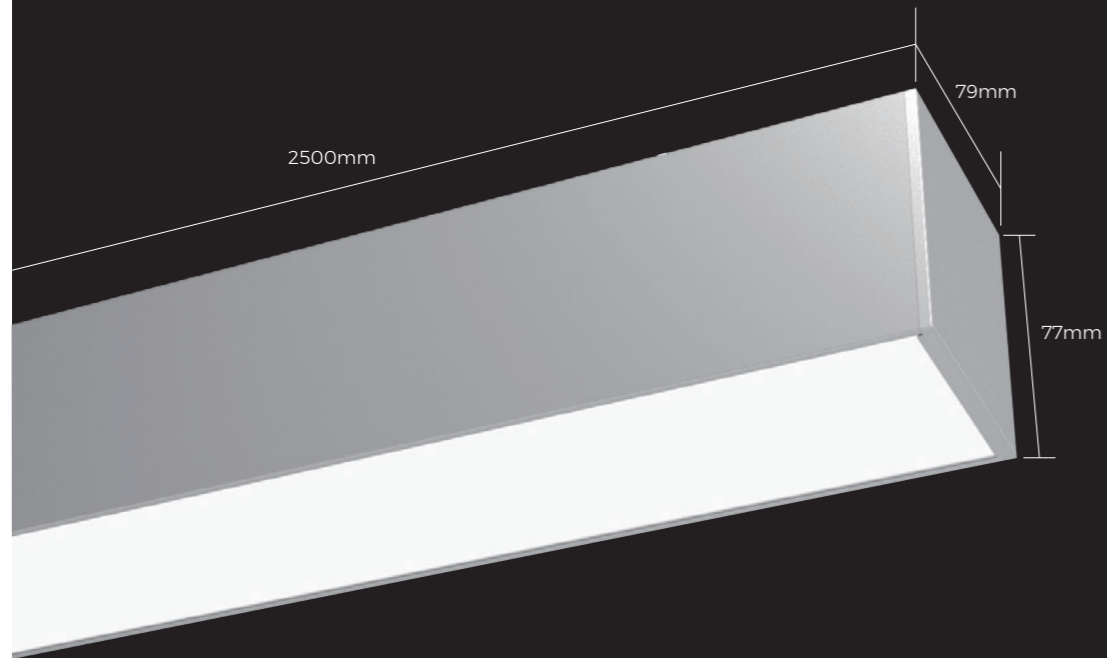

high	Ravg, Rmax	Luminous flux angle	diameter
1m	468.8, 15151x	108.79°	279.31cm
2m	117.2, 378.71x	108.79°	558.61cm
3m	52.09, 168.31x	108.79°	837.92cm
4m	29.30, 94.681x	108.79°	1117.23cm
5m	18.75, 60.601x	108.79°	1396.53cm
6m	13.02, 42.081x	108.79°	1675.84cm
7m	9.567, 30.921x	108.79°	1955.15cm
8m	7.325, 23.671x	108.79°	2234.45cm
9m	5.788, 18.701x	108.79°	2513.76cm
10m	4.688, 15.151x	108.79°	2793.07cm

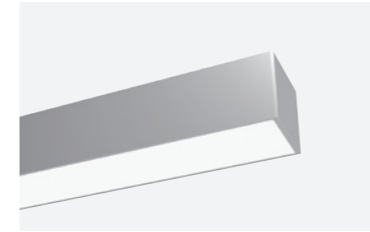

Profile

Material: aluminum 6063

Process: Anodizing/ Spraying

Color: Silver/ Black/ White

## Installation Accessories

Pendant Component (with ceiling box)	PY-D 2m/4m	
Pendant Component (without ceiling box)	PN-D 2m/4m	
Boundless embedded accessories	RE-04 135.4x25x90mm	
Ceiling accessories	CL-09 126x54x5.9mm	
Boom	PG-I	
Integrated Wiring Accessories	Dimming solution model CM-03 CM-06 Non-dimming solution model CM-04 CM-05	

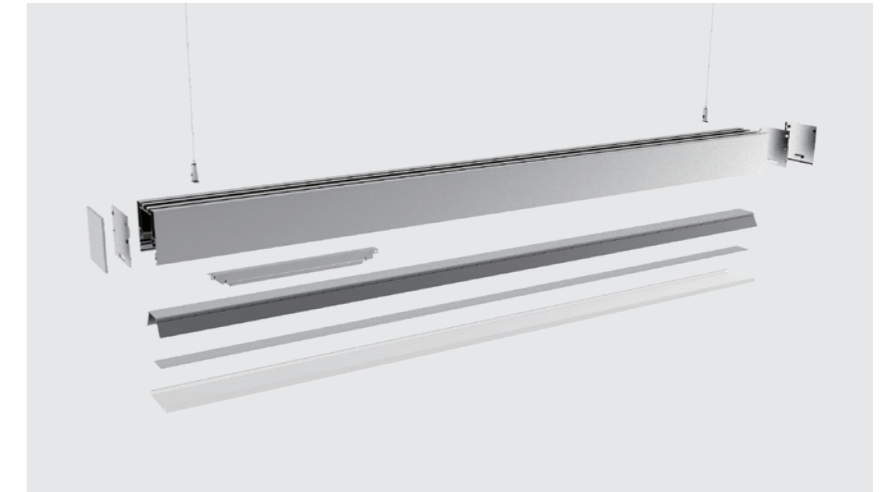

## Corner accessories

L-shaped Corner	L90-BS7977 150X150X77mm	
L-shaped Corner (Inward)	L90N-BS7977 150X150X79mm	
L-shaped Corner (Outward)	L90W-BS7977 150X150X79mm	
T-shaped corner	T90-BS7977 300X189.5X77mm	
X-shaped corner	X90-BS7977 300X300X77mm	

\* None of the five corners contains light sources.

## Connection Accessories

Extender	EX-40 150X49.2X32.9mm		Whole luminaire splicing bars	EX-41 110X1.5X11.7mm	
----------	--------------------------	--	-------------------------------	-------------------------	--

## Power Accessories

Model	Diameter	Output Voltage	Output Power	Diagram
BN-V24-060P-V1	329X30X17mm	24VDC	60W	

① Parts in profile components can be purchased separately.

② Being outfitted with or without light source in corners is optional.

③ The test result of product with luminous flux of 4000K.

④ You can select a power supply with lower power as per practical light effects demands.

# BH3360\_Component

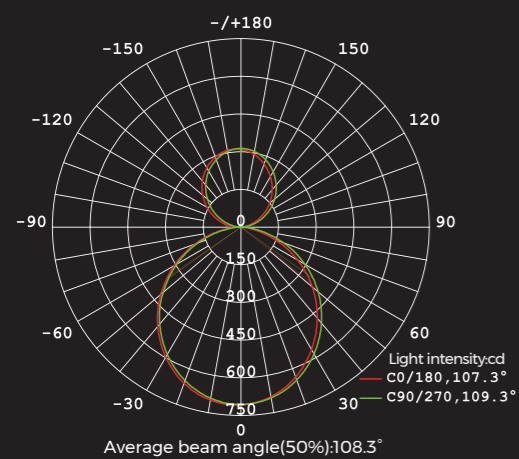
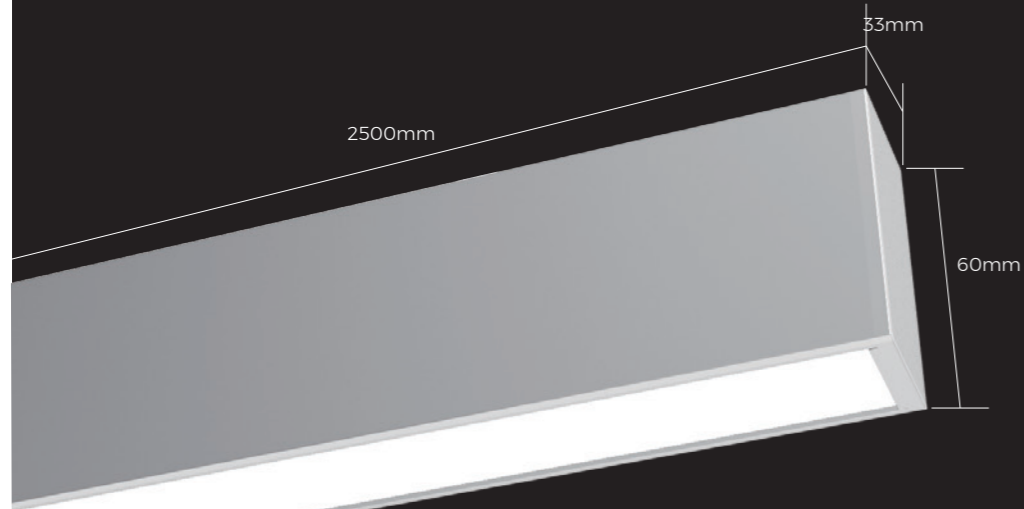

high	E <sub>avg</sub> , E <sub>max</sub>	Luminous flux angle: 108.3°	diameter
1m	222.3, 708.61x		276.80cm
2m	55.58, 177.11x		553.59cm
3m	24.70, 78.731x		830.39cm
4m	13.90, 44.281x		1107.19cm
5m	8.893, 28.341x		1383.99cm
6m	6.176, 19.681x		1660.78cm
7m	4.537, 14.461x		1937.58cm
8m	3.474, 11.071x		2214.38cm
9m	2.745, 8.7481x		2491.18cm
10m	2.223, 7.0861x		2767.97cm

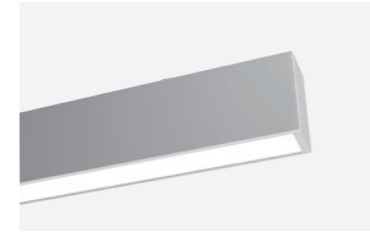

Profile

Material: aluminum 6063

Process: Anodizing/ Spraying

Color: Silver/ Black/ White

## Installation Accessories

Pendant Component (with ceiling box) PY-D 2m/4m

Pendant Component (without ceiling box) PN-D 2m/4m

Lifting clip CP-33

Integrated Wiring Accessories  
 Dimming solution model CM-03 CM-06  
 Non-dimming solution model CM-04 CM-05

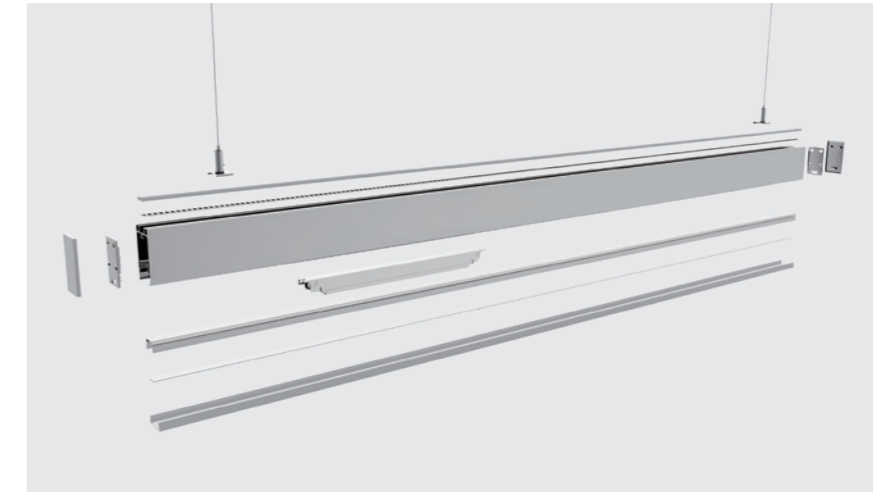

## Corner accessories

L-shaped Corner L90-BH3360 150X150X60mm

T-shaped corner T90-BH3360 300X166.5X60mm

X-shaped corner X90-BH3360 300X300X60mm

\* None of the three corners contains light sources.

## Connection Accessories

Extender EX-38 150X30X34.5mm Whole luminaire splicing bars EX-41 110X11.5X11.7mm

## Power Accessories

Model	Diameter	Output Voltage	Output Power	Diagram
BN-V24-060P-V1	329X30X17mm	24VDC	60W	

① Parts in profile components can be purchased separately.

② Being outfitted with or without light source in corners is optional.

③ The test result of product with luminous flux of 4000K.

④ You can select a power supply with lower power as per practical light effects demands.

# BH5470\_Component

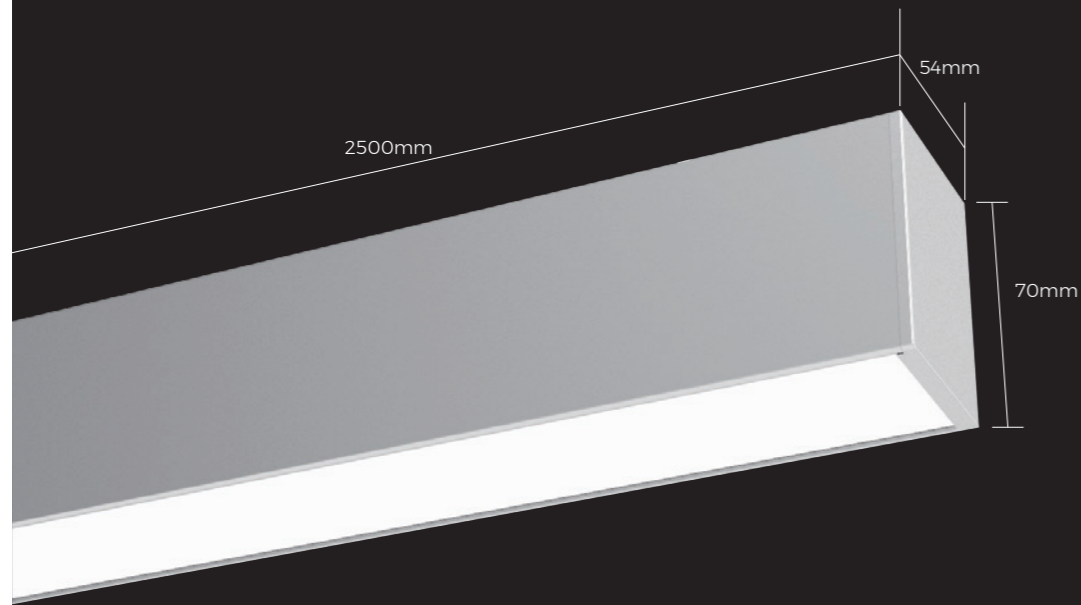

Profile

Material: aluminum 6063

Process: Anodizing/ Spraying

Color: Silver/ Black/ White

## Installation Accessories

Pendant Component (with ceiling box)	PY-D 2m/4m	
Pendant Component (without ceiling box)	PN-D 2m/4m	
Pendant rod	PG-I	
Lifting clip	CP-16	
Integrated Wiring Accessories	Dimming solution model CM-03 CM-06 Non-dimming solution model CM-04 CM-05	

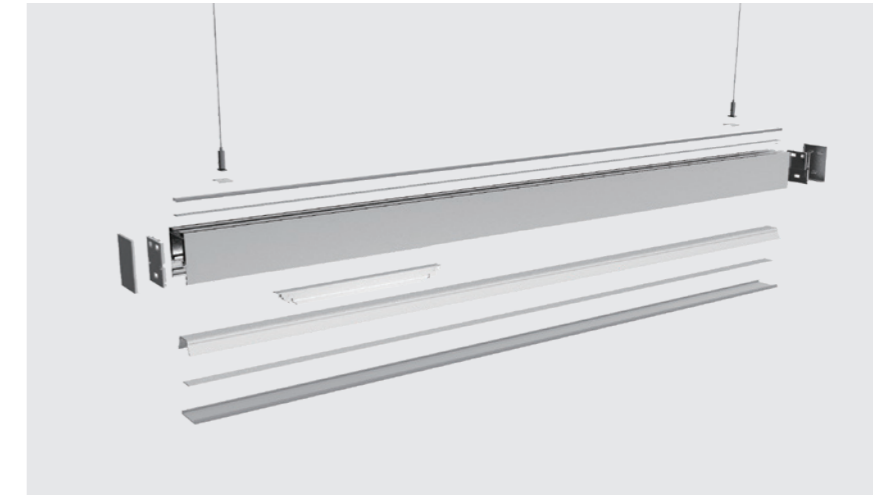

## Corner accessories

L-shaped Corner	L90-BH5470 150X150X70mm	
T-shaped corner	T90-BH5470 300X177X70mm	
X-shaped corner	X90-BH5470 300X300X70mm	

\* None of the three corners contains light sources.

## Connection Accessories

Extender	EX-39 150X37.2X29.8mm		Whole luminaire splicing bars	EX-41 110X15X11.7mm	
----------	--------------------------	--	-------------------------------	------------------------	--

## Power Accessories

Model	Diameter	Output Voltage	Output Power	Diagram
BN-V24-060P-V1	261X30X17mm	24VDC	60W	

① Parts in profile components can be purchased separately.

② Being outfitted with or without light source in corners is optional.

③ The test result of product with luminous flux of 4000K.

④ You can select a power supply with lower power as per practical light effects demands.

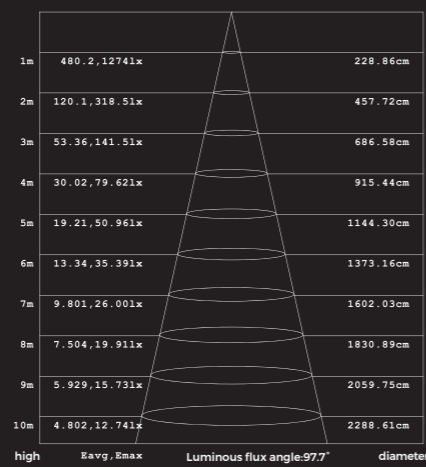
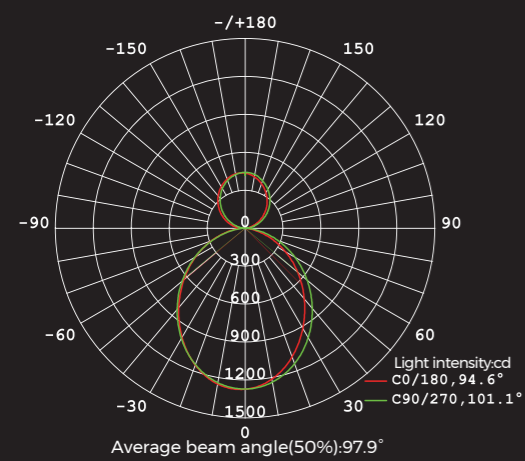

# BH7977\_Component

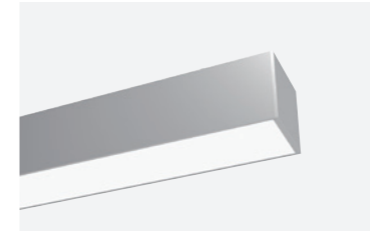
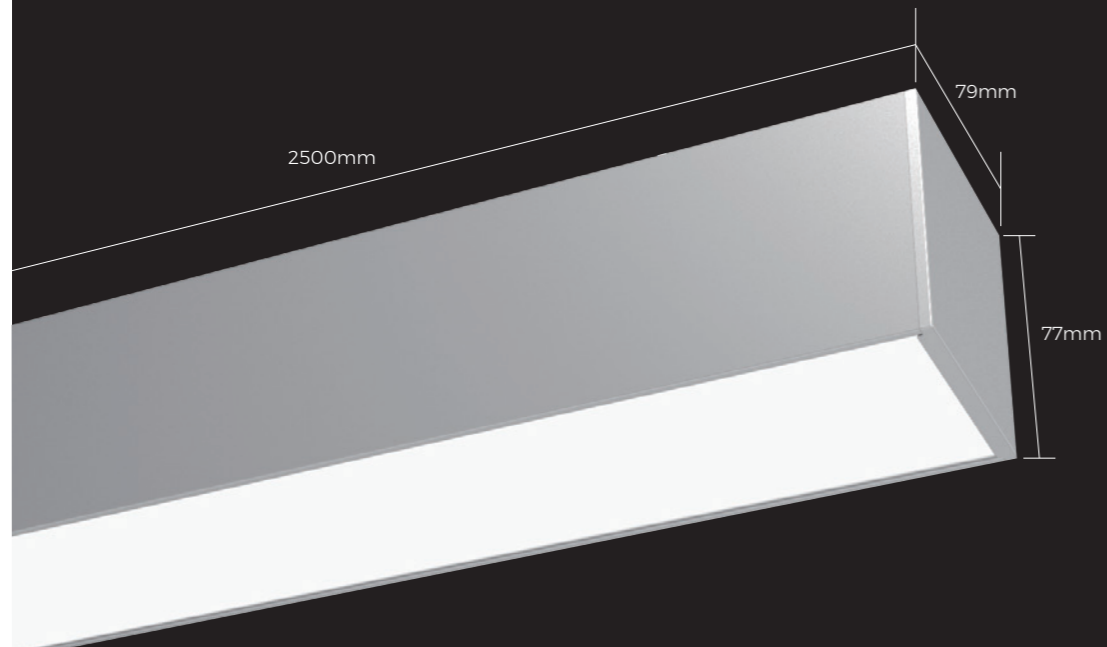

Profile

Material: aluminum 6063

Process: Anodizing/ Spraying

Color: Silver/ Black/ White

## Installation Accessories

Pendant Component (with ceiling box)	PY-D 2m/4m	
Pendant Component (without ceiling box)	PN-D 2m/4m	
Pendant rod	PG-I	
Lifting clip	CP-16	
Integrated Wiring Accessories	Dimming solution model CM-03 CM-06 Non-dimming solution model CM-04 CM-05	

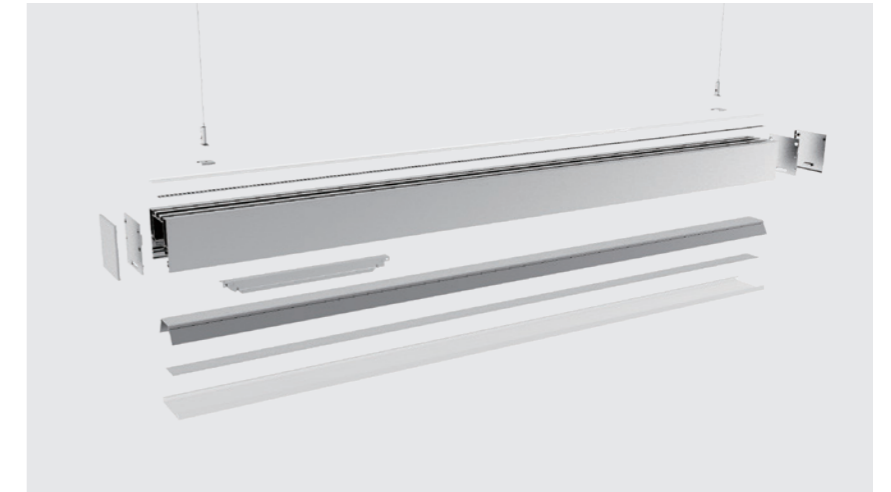

## Corner accessories

L-shaped Corner	L90-BH7977 150X150X77mm	
T-shaped corner	T90-BH7977 300X189.5X77mm	
X-shaped corner	X90-BH7977 300X300X77mm	

\* None of the three corners contains light sources.

## Connection Accessories

Extender	EX-40 150X49.2X32.9mm		Whole luminaire splicing bars	EX-41 110X11.5X11.7mm	
----------	--------------------------	--	-------------------------------	--------------------------	--

## Power Accessories

Model	Diameter	Output Voltage	Output Power	Diagram
BN-V24-060P-V1	26X30X17mm	24VDC	60W	

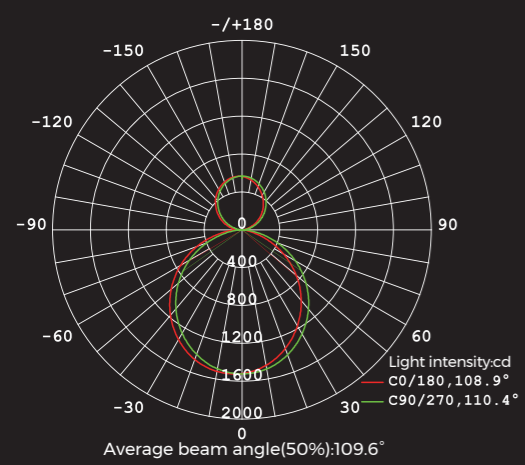

high	Ravg, Rmax	Luminous flux angle: 109.6°	diameter
1m	471.4, 15231x		283.52cm
2m	117.8, 380.71x		567.04cm
3m	52.38, 169.21x		850.55cm
4m	29.46, 95.171x		1134.07cm
5m	18.86, 60.911x		1417.59cm
6m	13.09, 42.301x		1701.11cm
7m	9.620, 31.081x		1984.63cm
8m	7.365, 23.791x		2268.14cm
9m	5.820, 18.801x		2551.66cm
10m	4.714, 15.231x		2835.18cm

① Parts in profile components can be purchased separately.

② Being outfitted with or without light source in corners is optional.

③ The test result of product with luminous flux of 4000K.

④ You can select a power supply with lower power as per practical light effects demands.

# BE5535\_Component NEW

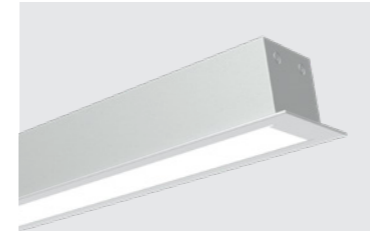

## Profile

Material: aluminum AL6063-T5

Process: Anodizing/ Spraying

Color: Silver/ Black/ White

## Installation Accessories

Recessed accessory **RB-02**  
L68.5xW35xH31.6mm 

Integrated Wiring Accessories  
Dimming solution model **CM-03 CM-06**  
Non-dimming solution model **CM-04 CM-05** 

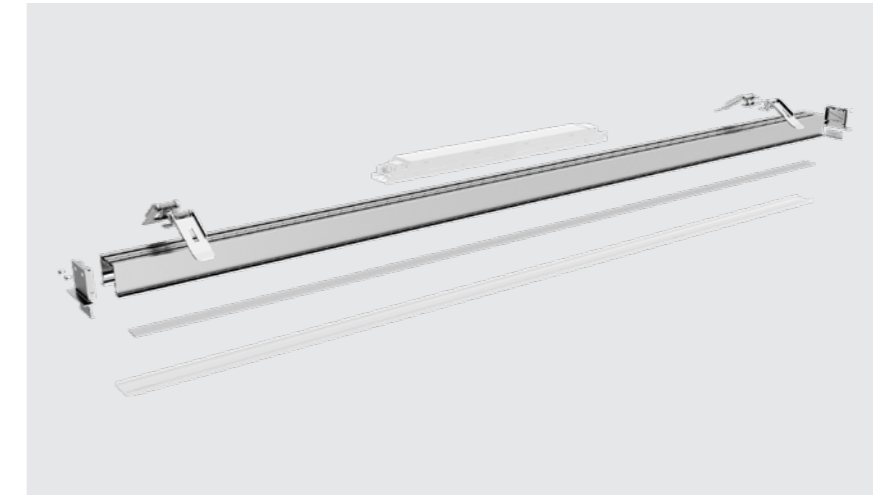



## Corner accessories

L-shaped Corner **L90-BE6935**  
150X150X35mm 

L-shaped Corner (Inward) **L90N-BE6935**  
150X150X69mm 

L-shaped Corner (Outward) **L90W-BE6935**  
150X150X69mm 

T-shaped corner **T90-BE6935**  
300X184.5X35mm 

X-shaped corner **X90-BE6935**  
300X300X35mm 

\* None of the five corners contains light sources.

## Connection Accessories

Extender **EX-17** **50X9X22.5mm** 

## Power Accessories

Model	Diameter	Output Voltage	Output Power	Diagram
BN-V24-060P-V1	261X30X17mm	24VDC	60W	

① Parts in profile components can be purchased separately.

② Being outfitted with or without light source in corners is optional.

③ The test result of product with luminous flux of 4000K.

④ You can select a power supply with lower power as per practical light effects demands.

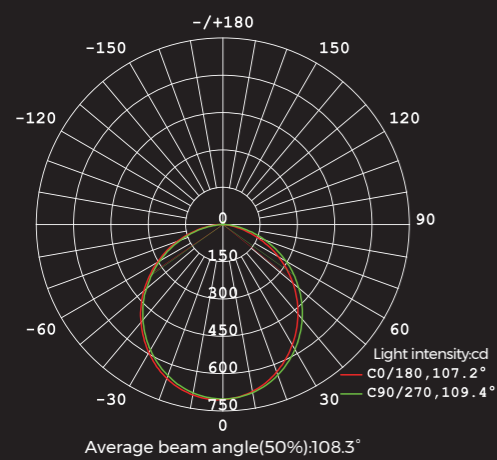

high	Eavg, Emax	Luminous flux angle: 107.23°	diameter
1m	226.8, 704.2lx		271.42cm
2m	56.69, 176.0lx		542.85cm
3m	25.20, 78.24lx		814.27cm
4m	14.17, 44.01lx		1085.69cm
5m	9.071, 28.17lx		1357.12cm
6m	6.299, 19.56lx		1628.54cm
7m	4.628, 14.37lx		1899.96cm
8m	3.543, 11.00lx		2171.38cm
9m	2.800, 8.693lx		2442.81cm
10m	2.268, 7.042lx		2714.23cm

# BE6935\_Component

NEW

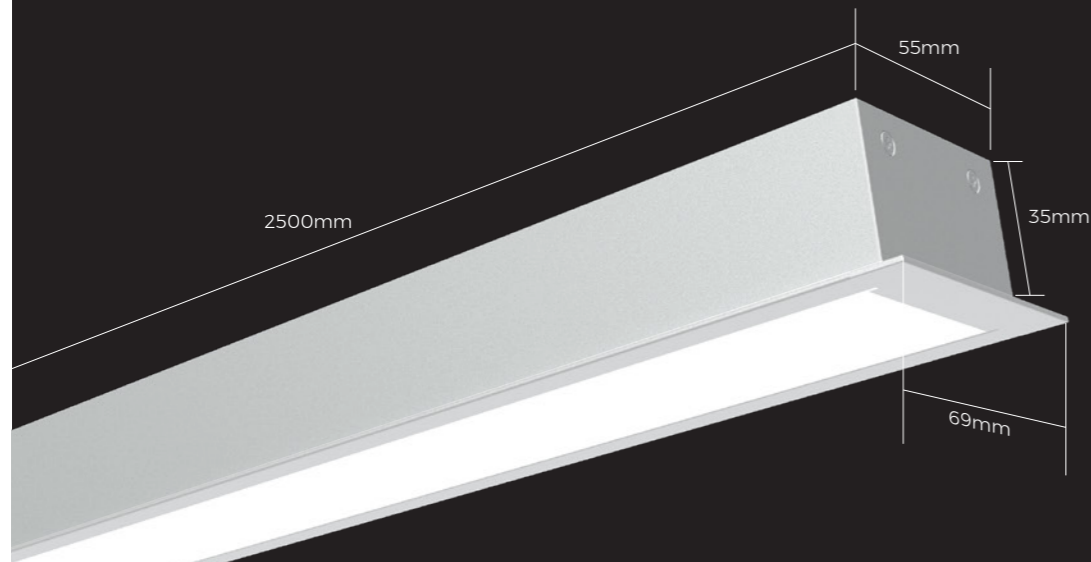

Profile

Material: aluminum AL6063-T5

Process: Anodizing/ Spraying

Color: Silver/ Black/ White

## Installation Accessories

Recessed accessory **RB-02**  
L68.5xW35xH31.6mm

Integrated Wiring Accessories  
Dimming solution model **CM-03 CM-06**  
Non-dimming solution model **CM-04 CM-05**

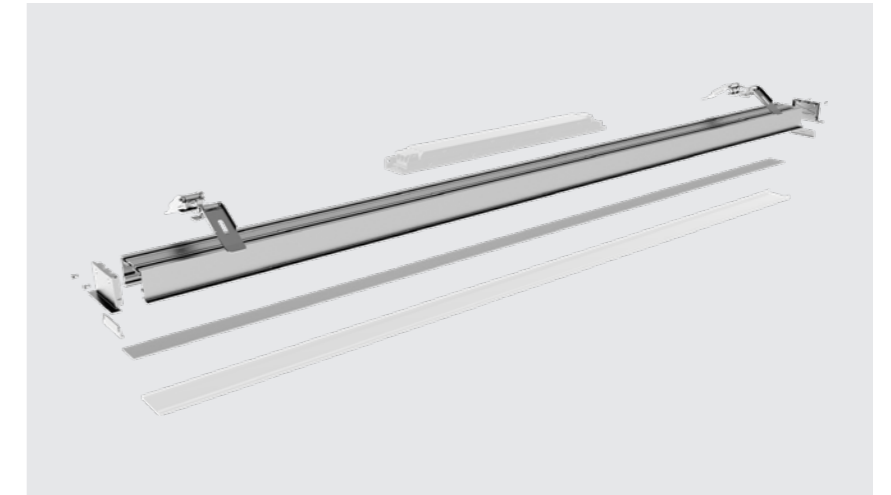

## Corner accessories

L-shaped Corner **L90-BE6935**  
150X150X35mm

L-shaped Corner (Inward) **L90N-BE6935**  
150X150X69mm

L-shaped Corner (Outward) **L90W-BE6935**  
150X150X69mm

T-shaped corner **T90-BE6935**  
300X184.5X35mm

X-shaped corner **X90-BE6935**  
300X300X35mm

\* None of the five corners contains light sources.

## Connection Accessories

Extender **EX-17** 50X9X22.5mm

## Power Accessories

Model	Diameter	Output Voltage	Output Power	Diagram
BN-V24-060P-V1	261X30X7mm	24VDC	60W	

① Parts in profile components can be purchased separately.

② Being outfitted with or without light source in corners is optional.

③ The test result of product with luminous flux of 4000K.

④ You can select a power supply with lower power as per practical light effects demands.

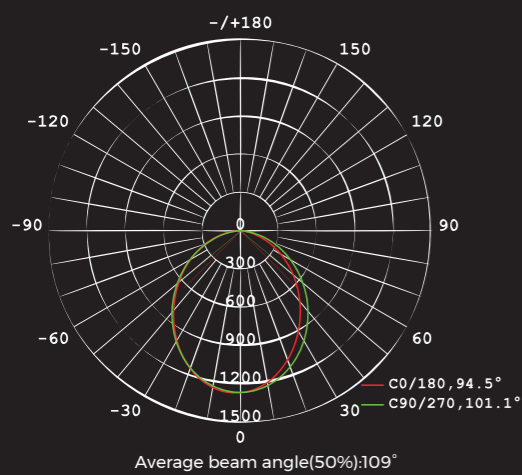

high	E <sub>avg</sub>	E <sub>max</sub>	Luminous flux angle: 94.54°	diameter
1m	498.9	12691x		216.52cm
2m	124.7	317.11x		433.04cm
3m	55.43	141.01x		649.56cm
4m	31.18	79.291x		866.08cm
5m	19.95	50.741x		1082.60cm
6m	13.86	35.241x		1299.12cm
7m	10.18	25.891x		1515.63cm
8m	7.795	19.821x		1732.15cm
9m	6.159	15.661x		1948.67cm
10m	4.989	12.691x		2165.19cm



# BE9435\_Component NEW

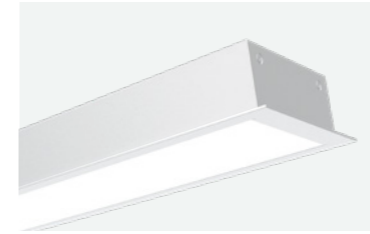

## Profile

Material: aluminum AL6063-T5

Process: Anodizing/ Spraying

Color: Silver/ Black/ White

## Installation Accessories

Recessed accessory **RB-02**  
L68.5xW35xH31.6mm

Integrated Wiring Accessories  
Dimming solution model **CM-03 CM-06**  
Non-dimming solution model **CM-04 CM-05**

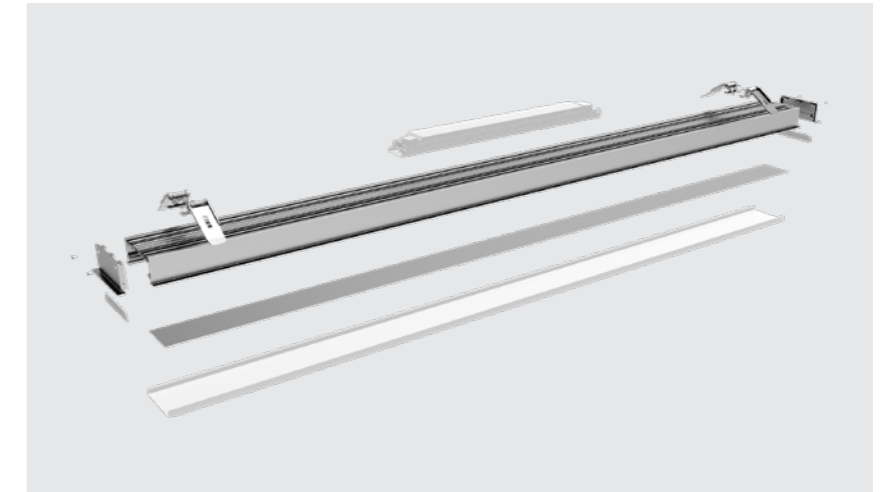

## Corner accessories

L-shaped Corner **L90N-BE9435**  
150X150X35mm

L-shaped Corner (Inward) **L90W-BE9435**  
150X150X94mm

L-shaped Corner (Outward) **L90-BE9435**  
150X150X94mm

T-shaped corner **T90-BE9435**  
300X197.5X35mm

X-shaped corner **X90-BE9435**  
300X300X35mm

\* None of the five corners contains light sources.

## Connection Accessories

Extender **EX-17** 50X9X22.5mm

## Power Accessories

Model	Diameter	Output Voltage	Output Power	Diagram
BN-V24-060P-V1	329X30X17mm	24VDC	60W	

① Parts in profile components can be purchased separately.

② Being outfitted with or without light source in corners is optional.

③ The test result of product with luminous flux of 4000K.

④ You can select a power supply with lower power as per practical light effects demands.

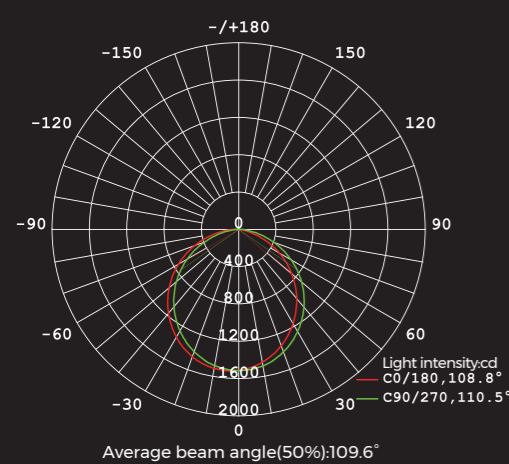

high	Eavg, Emax	Luminous flux angle:108.79°	diameter
1m	468.8, 1515lx		279.31cm
2m	117.2, 378.7lx		558.61cm
3m	52.09, 168.3lx		837.92cm
4m	29.30, 94.60lx		1117.23cm
5m	18.75, 60.60lx		1396.53cm
6m	13.02, 42.08lx		1675.84cm
7m	9.567, 30.92lx		1955.15cm
8m	7.325, 23.67lx		2234.45cm
9m	5.788, 18.70lx		2513.76cm
10m	4.688, 15.15lx		2793.07cm



Tel: +86 755-2613 5888

Mail: [sales@colorsled.com](mailto:sales@colorsled.com)

Marketing Center: Room 1201, Block A, Kingkey Timemark, Futian District, Shenzhen, Guangdong, China

R&D Center: Building A1, Jiushun Industrial Park, Shiyan, Bao'an District, Shenzhen, Guangdong, China

Manufacture Center: Huacai Industry Park, Zhong'ai Village, Jiangdu District, Yangzhou, Jiangsu, China

All rights of the pictures reversed by their representative owners